

POLICY

FOR

ROADSIDE VEGETATION

MANAGEMENT

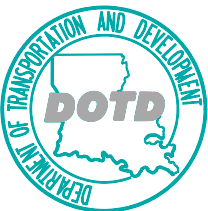

**LOUISIANA DEPARTMENT OF TRANSPORTATION
AND DEVELOPMENT**



TABLE OF CONTENTS

PAGE	
	INTRODUCTION 1
1.	GUIDELINES AND CATEGORIES OF ROADSIDE VEGETATIVE MAINTENANCE
	General Conditions.....2
	Urban.....3
	Rural.....4
	Intersections (All Systems)6
	Mowing Exceptions6
	General Vegetation Management Plan.....7
	Typical Vegetation Management Section
	Rural Interstate.....8
	Typical Vegetation Management Section
	Rural Primary Multi-Lane.....9
	Typical Vegetation Management Section
	Rural Primary Two-Lane10
	Typical Vegetation Management Section
	Rural Secondary and Farm to Market11
	Sight Distances for Signs and Intersections12
II.	HERBICIDES
	Laws and Regulations13
	General.....13
	Factors of Herbicides Application.....14-17
	Herbicide Chart18-19
	Daily Herbicide Spraying Report.....20
III.	WILDFLOWERS
	General.....21
	Establishment of Wildflower Areas21-23
	Louisiana DOTD Wildflower Inventory Form.....24
	Wildflower Seed Producers.....25
	Roster of Officials26
IV.	LANDSCAPING
	General27
	Functions of Highway Planting Design.....28-31
	Criteria for Landscaping Interstate and
	Major Primary Routes.....32,33
	Criteria for Landscaping Arterial Roads, Collector Roads,
	Local Roads and Streets34,35
	Louisiana Department of Transportation and Development
	Design Standards 1 of 4 thru 4 of 4
	Planting List36-40
	Typical Urban Clover Leaf Interchange.....41
	Typical Urban Diamond Interchange42
	Typical Rural Interchange43
	Median Planting for Barrier Curbed Roadways44

Minimum Setbacks for Highway Plantings without
Barrier Curbs for Primary and Secondary Routes.....45
Sight Distance Requirements at Typical Intersections46

V. **GUIDELINES FOR VEGETATION VISIBILITY PERMITS**

General47
Procedure.....47-49
Diagram 150
Diagram 2.....51

VI. **EDSM No: I.1.1.21**

Treatment of significant trees in DOTD Right-of-Way52-54

INTRODUCTION

The authority of this manual is given in Act No. 682 of the Regular Session of the State Legislature of 1989.

The DOTD Rule entitled "Roadside Vegetation Management" was published as a final rule in the August 20, 2000, issue of the *Louisiana Register*. August 20, 2000, is the rule's effective date.

Under normal budgetary conditions, the vegetation control guidelines as described herein should be followed as closely as possible. However, during times of severe budget restraints when state revenues are not available to fund this vegetation control policy, it may be necessary to adjust guidelines to operate within the reduced budget.

Items addressed in this manual include: Guidelines and Categories of Roadside Vegetative Maintenance, Herbicides, Wildflowers and Landscaping.

Deviation from policies in this manual must have written approval of the DOTD Chief Landscape Architect and the DOTD Chief Engineer.

Roadside vegetative maintenance guidelines are intended to accomplish the following objectives:

1. Provide for safety of the traveling public
2. Blend the roadside with adjacent land uses
3. Improve aesthetic quality
4. Reduce erosion
5. Increase efficiency of maintenance operations

**GUIDELINES AND CATEGORIES OF
ROADSIDE VEGETATIVE MAINTENANCE**

1. GENERAL CONDITIONS FOR ALL HIGHWAY SYSTEMS

1. DOTD will encourage the growth, planting and preservation of wildflower areas.
2. The District Roadside Development Coordinator shall monitor and coordinate planting of all wildflower areas. He will record locations of the plantings on DOTD Wildflower Inventory form and return them to Headquarters for placement in the master file. Refer to page 24 for a copy of this form.
3. Wildflowers may be planted to within 30 feet of the roadway on multi-lane systems and 15 feet on two-lane facilities or the back of the required drainage channel, whichever is greater. Wildflowers that have naturalized and are 15 feet or more from the travel lane should be allowed to remain. Every effort should be made to mow around them and avoid spraying herbicides unless it is spot treatment to eliminate certain weed species. Wildflowers may be planted in medians providing that they do not interfere with sight distances as outlined on page 44. Naturalized species occurring in wet areas such as iris, lilies and cattails will be allowed to remain when they do not obstruct drainage. The District Maintenance Engineer will decide when plants are obstructing drainage or sight distances and will take the necessary action to correct the deficiency. For sight distances at intersections, see page 46.
4. Remove litter prior to mowing designated areas. For roads in the Adopt-A-Road program, it would be beneficial to contact the sponsor agency and advise them of the mowing schedule in order for them to assist in the removal of litter prior to the mowing operation.
5. Sight distance at horizontal curves, vertical curves, intersections, railroad crossings, signs, signal lights, delineators, hazard markers and warning devices should be clear of obstructions. Sight distance can be obtained on the inside of horizontal curves by mowing the area 30 feet from the edge of the surface or from the edge of the surface to the right-of-way line or from the edge of the surface to the fence line, whichever is the shortest distance. Transition should begin 150 feet prior to the beginning and end of the curve. All vegetation shall be maintained to permit clear visibility for all regulatory traffic signs. Trim or remove trees that interfere with proper sight distance or side and overhead clearance. Refer to pages 12 and 46 for proper sight distances.

6. All dead trees or leaning trees with weakened root systems within DOTD rights-of-way which may endanger traffic by falling across the highway shall be removed and disposed of in a timely manner. Stumps within a mowable area are to be removed to ground level with a stump removing machine. If the stumps are located in an area designated not to be mowed, they may remain but should be cut to within 5 inches of ground level.
 7. In order to ensure proper drainage, mow to the top of backslopes. When ditch bottoms are inaccessible and impeding drainage, treat unwanted vegetation with an approved herbicide labeled for use over water.
 8. Mowing heights should be 5"-6", shorter cutting heights may cause stress on the vegetation and damage to equipment. Do not mow during long rainy spells and when the right-of-way is too wet. Mowing during these times will cause rutting and possibly cause erosion in the future.
 9. Observe and initiate appropriate erosion control procedures when necessary.
 10. General herbicide treatment is to be confined to an area of approximately 30 foot widths from the edge of all roadways where right-of-way is available or to the back of the required drainage channel to ensure proper drainage. Spot treatment is allowable beyond this area.
 11. Treat pavement edges, paved medians, riprap areas and areas around delineators, guardrails and signs with appropriate herbicide. Treat designated areas of roadsides with appropriate herbicide two weeks prior to mowing cycle to eliminate noxious grasses and weeds. Some areas may need hand trimming because of herbicide restrictions. Prior to treating rights-of-way on federally owned lands, obtain the proper authorization from the federal agency having jurisdiction and make herbicide applications in accordance with their guidelines. DO NOT SPRAY HERBICIDES IN DESIGNATED OR NATIVE STANDS OF WILDFLOWERS UNLESS ABSOLUTELY NECESSARY TO CONTROL WEED INFESTATION. When treating unwanted vegetation in wildflower areas, every effort should be made to spot treat the unwanted vegetation.
 12. When practical, every attempt should be made to blend the highway right-of-way with the adjacent land uses. For example, forest lands should extend into the right-of-way, subject to clear zone requirements, and rights-of-way adjacent to crops and pasture lands should remain relatively open, etc.
- II. **URBAN** (Highway Systems) Urban shall mean within the recognized limits of small towns, villages and municipalities as well as incorporated areas of cities.
1. Maintain all rights-of-way by using a minimum cutting height of 5". A maximum height of 18" will be allowed prior to mowing.

2. Remove all dead ornamental plants and replace during the proper planting season with appropriate type of plant.
3. Wildflowers may be planted in large interchange areas and shall not be mowed until the mature seed has set. Utilize the 5" minimum mowing height up to the limits of the wildflower planting area. Wildflowers which will attain a height of 24" or more will not be permitted in narrow medians or in sight triangles where they will interfere with adequate sight distances. General Conditions, No. I-3 outlines other facts concerning wildflower plantings.
4. Transition mowing standards between urban and rural categories with a long, smooth, flowing line. This transition should occur over a distance of approximately 2,000 feet.

III. **RURAL**

A. INTERSTATE (Refer to Section, pg. 8)

1. Begin mowing operations, except wildflower areas once vegetation has reached approximately 12" in height. Maintain right-of-way using a 5" cutting height.
2. Mow all mowable areas, except wildflower areas a minimum of three times each year. Medians are to be mowed in their entirety each mowing cycle except where wildflowers, shrubs or trees are present. Weather permitting, these mowings should occur in May, August and in late October or November.
3. Wildflowers will be permitted as in No. II-3 under Urban Systems. Maintain the 12" to 18" maximum vegetation height up to the limits of the wildflower planting area. Wildflower areas are allowed to naturally reseed within 15 feet of travel lane.
4. Mow wildflower areas after they have gone to seed. For spring blooming varieties this should normally occur in May and fall blooming plants should be mowed in late October or November. The Roadside Development District Coordinator should be consulted to determine appropriate timing for mowing wildflower areas.

5. Remove all dead ornamental plants and replace during the proper planting season with appropriate type of plant.
6. Herbicide applications are to be made in accordance with General Conditions, No. I-11 & 12.
7. Maintain frontage roads in the same manner as primary system.
8. Weigh scale areas are to be mowed in their entirety each mowing cycle using a 5" mowing height.
9. Rest areas are to be mowed in accordance with EDSM No. IV.3.1.2.

B. PRIMARY MULTI-LANE AND TWO LANE (Refer to Sections, pgs. 9 & 10)

1. Begin mowing operations once vegetation has reached approximately 12" in height, unless herbicides have established desirable vegetation and rendered mowing unnecessary. Mowing heights are to be 5".
2. Mow a 30 foot strip from the edge of the roadway surface or to the back edge of the ditch to facilitate drainage, or to the right-of-way on multi-lane and two lane roadways. Medians less than 80 feet in width are to be mowed in their entirety each mowing cycle. In medians which have been allowed to revegetate naturally, mow 30 foot strip from the edge of the roadway surface or to the back edge of the ditch. Mowing should be accomplished a minimum of three times per year.
3. Wildflowers will be permitted as in No. I-3, under General Conditions and in No. II-3, Urban.
4. Mow entire mowable area of the right-of-way annually in late October and November after the wildflowers have bloomed and the seed has set. In areas which have been allowed to revegetate naturally, annually mow a 40 foot strip to eliminate woody growth.
5. Mow interchange areas to same standards as roadways.
6. Herbicide applications are to be made in accordance with General Conditions, No. I-11 & 12.
7. Maintain frontage roads in the same manner as primary system.

C. SECONDARY AND FARM-TO-MARKET SYSTEM

(Refer to Section, pg. 11)

1. Begin mowing operations once vegetation has reached a 12" height. Mowing heights are to be 4"-6"
2. Mow a 15 foot strip from the edges of the roadway surface or to the back

side of the ditch to facilitate drainage.

3. Herbicide applications are to be made in accordance with General Conditions, No. I-11 & 12 or as determined by District personnel based on existing conditions.
4. Annually mow entire mowable area in the fall, normally in late October or November after wildflowers have bloomed and the seed has set to prevent excessive woody growth.

IV. INTERSECTIONS (All Systems)

1. Right-of-way permitting, mow to the sight distance transition limits specified on page 12.
2. Mow all flare areas at junctions for sight distance.

V. MOWING EXCEPTIONS

1. Areas where individuals or businesses mow right-of-way along their property.
2. Areas where appropriate herbicide treatment can keep vegetation within the standards.
3. Areas that are not applicable, i.e., wildflower areas.
4. Areas where seedlings are planted and/or permitted to grow.
5. Rest areas and tourist information centers, on the interstate system, are to be maintained by the caretakers in a lawn-type condition.
6. Unmowable areas within defined mowing limits.

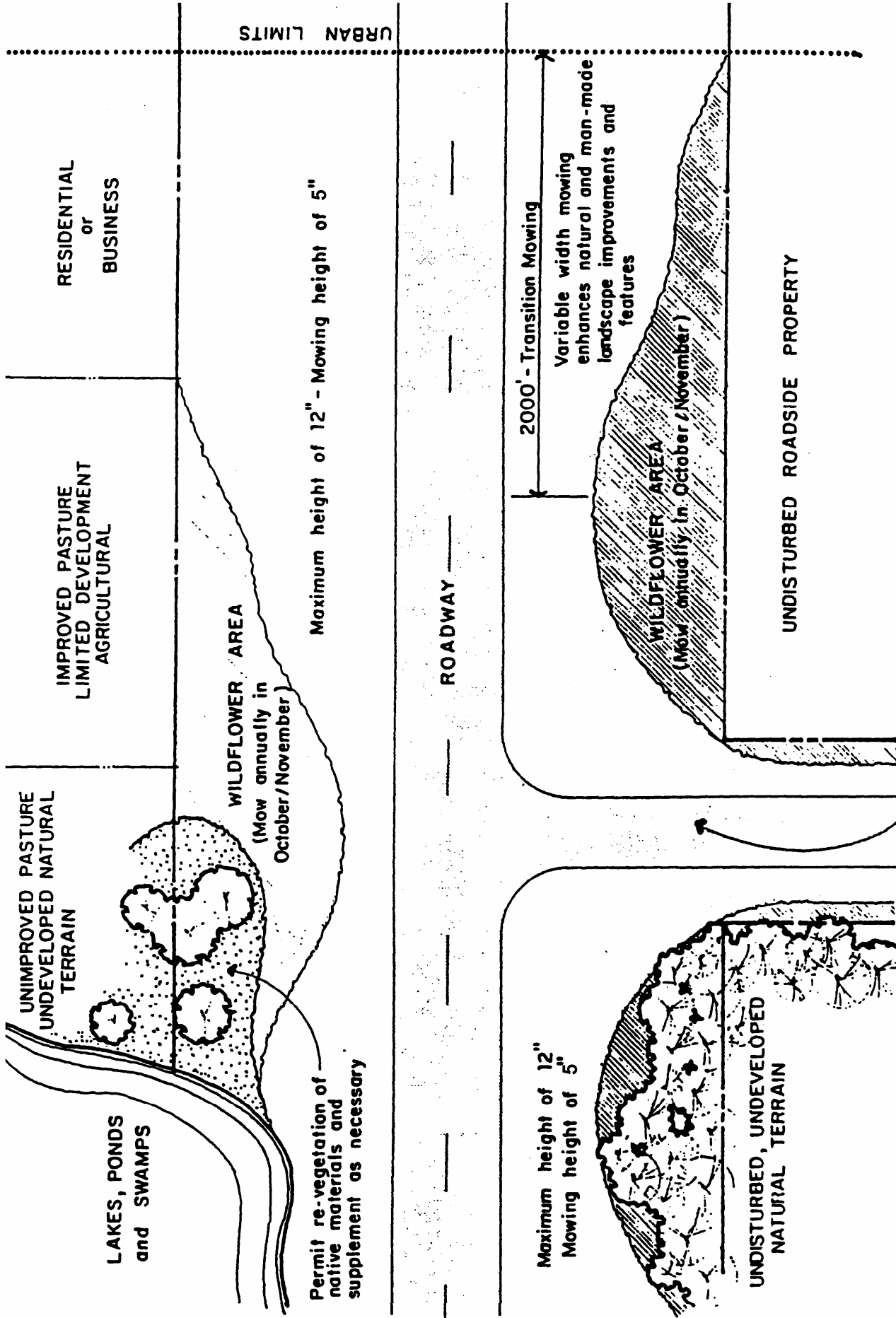

Intersections of State and Parish
Roads and major driveways

GENERAL VEGETATION MANAGEMENT PLAN

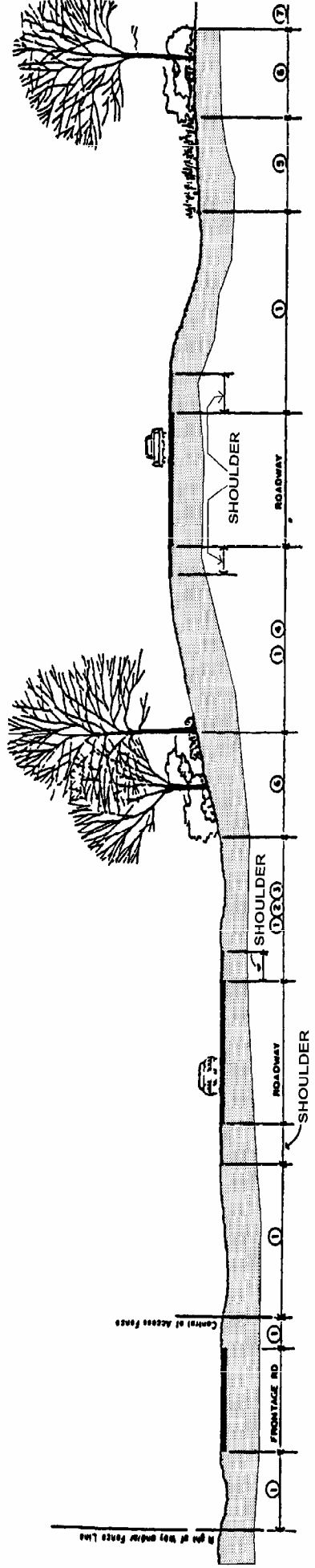

- ① When vegetation reaches a height of 12" mow all mowable areas of the right-of-way (tree line to tree line or fence line to fence line). Mowing height should be 5". Medians are to be mowed in their entirety each mowing cycle except when wildflowers or native shrub and or trees are present.
- ② General herbicide treatment is to be confined to an area of approximately 30 feet in width from the edge of all roadways, where right-of-way is available, or to the back of the required drainage channel to insure proper drainage. Spot treatment is allowable beyond this area to eliminate weed species. Avoid spraying wildflowers and other desirable vegetation. Refer to general condition 1-12 and herbicide chapter for additional information.
- ③ Native shrubs may be allowed to revegetate to a distance of 30' from the edge of the roadway.
- ④ Native trees which will attain a trunk diameter of 4" or greater, may be allowed to revegetate to a distance of 50' from the edge of the roadway.
- ⑤ Wildflower areas - Do not mow until wildflowers have gone to seed. Refer to wildflower chapter for additional information.
- ⑥ Area of natural revegetation - Do not mow in this area.
- ⑦ Mow a 7'-0" wide strip along the right-of-way line or fence line where feasible.

TYPICAL VEGETATION MANAGEMENT SECTION RURAL, INTERSTATE

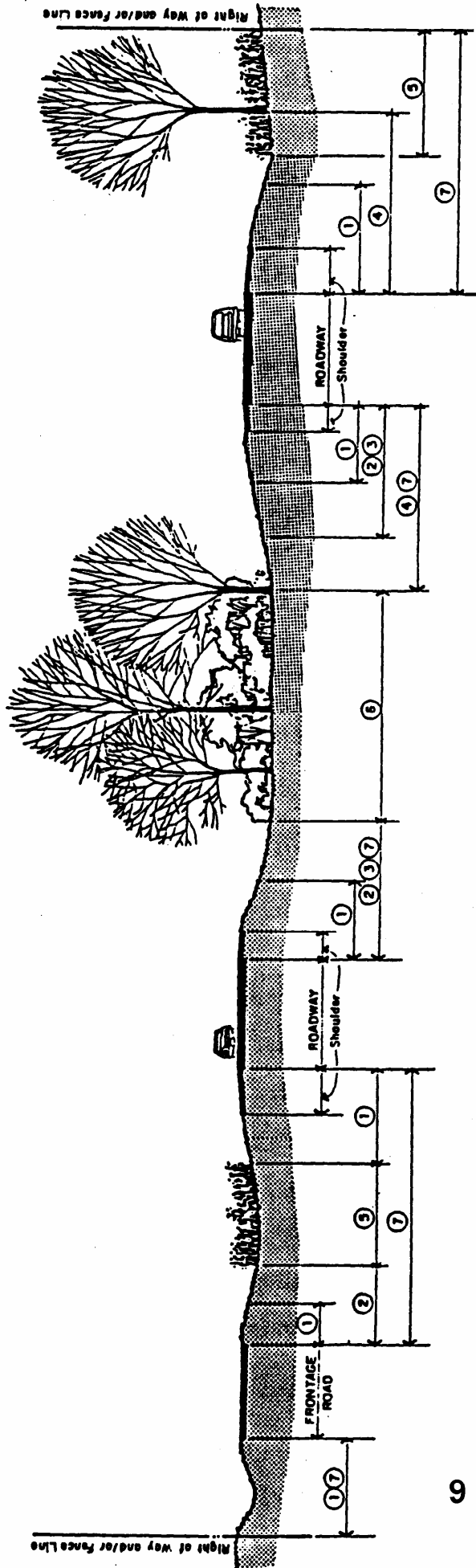

- ① When vegetation reaches a height of 12", mow a 30' strip from the edge of the roadway surface or to the top of the backslope to facilitate drainage. Mowing height should be 5". Medians less than 80' wide are to be mowed in their entirety each mowing cycle unless wildflowers are present. If wildflowers are present, mow around them. Delay mowing the wildflower area until after they have gone to seed. Along frontage roads, mow a 7' wide strip from the edges of the roadway surface or to the back side of the ditch to facilitate drainage.
- ② General herbicide treatment is to be confined to an area of approximately 30 feet in width from the edge of all roadways, where right-of-way is available, or to the back of the required drainage channel to insure proper drainage. Spot treatment is allowable beyond this area to eliminate weed species. Avoid spraying wildflowers and other desirable vegetation. Refer to general condition 1-12 and herbicide chapter for additional information.
- ③ Native shrubs may be allowed to revegetate to a distance of 30' from the edge of the roadway.
- ④ Native trees, which will attain a trunk diameter of 4" or greater, may be allowed to revegetate to a distance of 40' from the edge of the roadway.
- ⑤ Wildflower areas - Do not mow until wildflowers have gone to seed. Refer to wildflower chapter for additional information.
- ⑥ Area of natural revegetation - Do not mow in this area.
- ⑦ Mow entire mowable area of the right-of-way annually in late October and November after the wildflowers have bloomed and the seeds have set. In areas which have been allowed to revegetate naturally, mow a 40' wide strip, or to the limits of shrubs and trees.

TYPICAL VEGETATION MANAGEMENT SECTION RURAL, PRIMARY MULTI-LANE

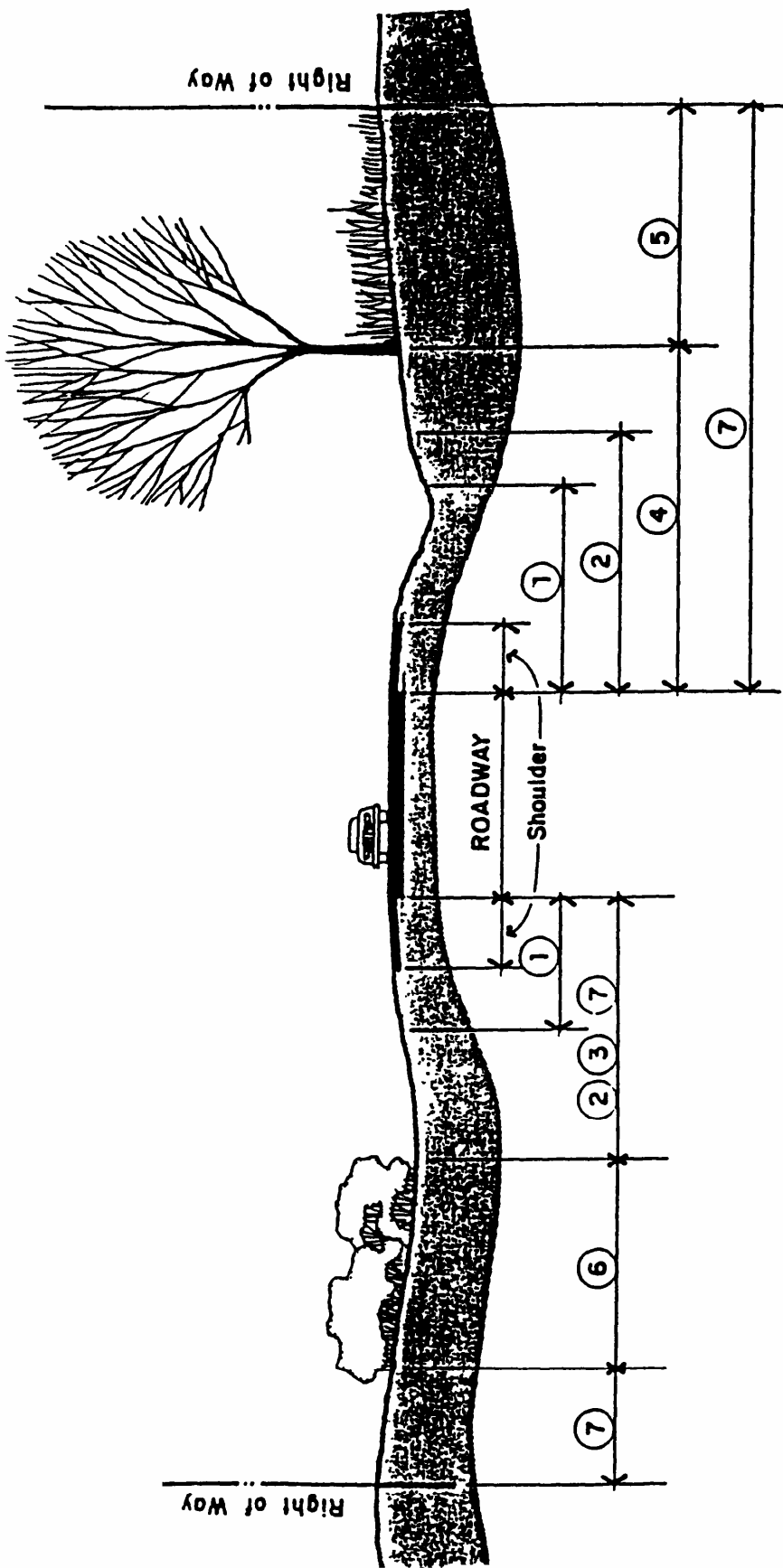

- ① When vegetation reaches a height of 12", mow a 30' wide strip from the edge of the roadway surface or to the top of the backslope to facilitate drainage. Mowing height should be 5". If wildflowers are present, mow around them. Delay mowing the wildflower areas until after they have gone to seed.
- ② General herbicide treatment is to be confined to an area of approximately 30 feet in width from the edge of all roadways, where right-of-way is available, or to the back of the required drainage channel to insure proper drainage. Spot treatment is allowable beyond this area to eliminate weed species. Avoid spraying wildflowers and other desirable vegetation. Refer to general condition I-12 and herbicide chapter for additional information.
- ③ Native shrubs may be allowed to revegetate to a distance of 30' from the edge of the roadway.
- ④ Native trees, which will attain a trunk diameter of 4" or greater, may be allowed to revegetate to a distance of 40' from the edge of the roadway.
- ⑤ Wildflower areas - Do not mow until wildflowers have gone to seed. Refer to wildflower chapter for additional information.
- ⑥ Area of natural revegetation - Do not mow in this area.
- ⑦ Mow entire mowable area of the right-of-way annually in late October and November after the wildflowers have bloomed and the seeds have set. In areas which have been allowed to revegetate naturally, mow a 40' wide strip or to the limits of shrubs and trees.

TYPICAL VEGETATION MANAGEMENT SECTION RURAL, PRIMARY TWO LANE

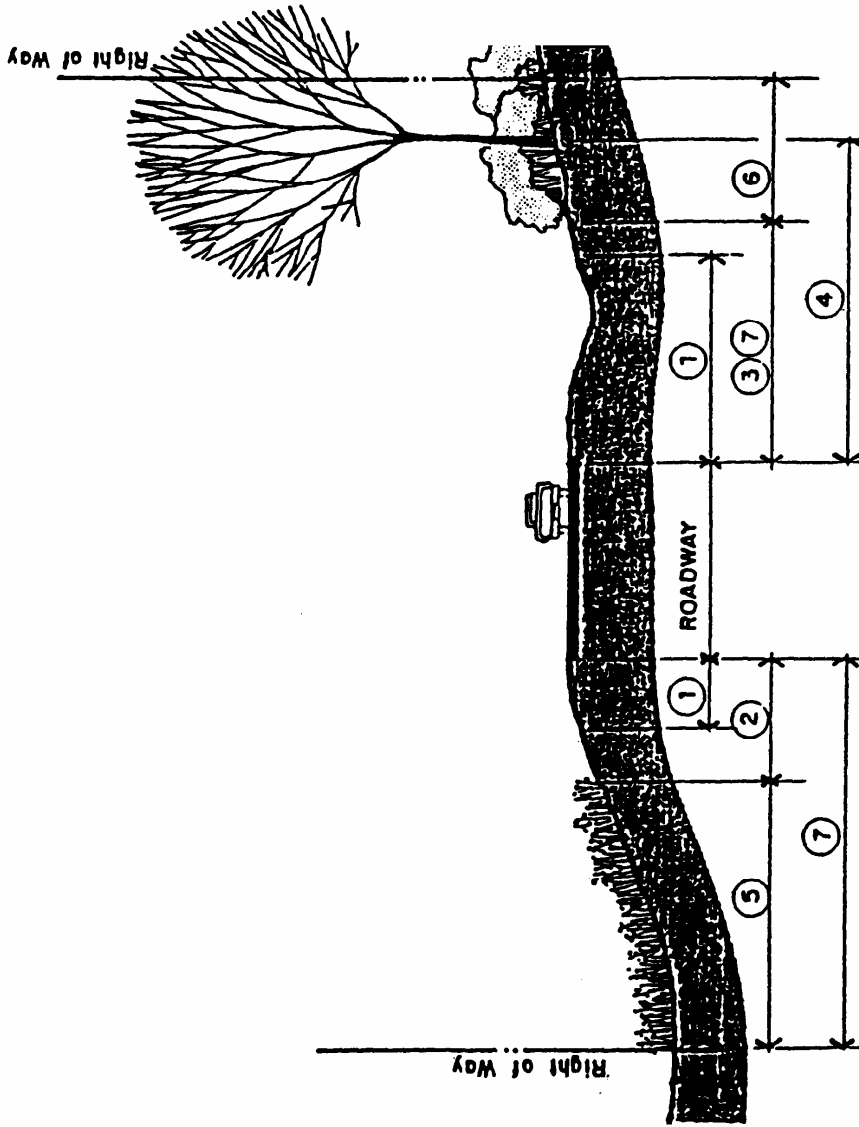

- ① When vegetation reaches a height of 12", mow a 15' strip from the edge of the roadway surface or to the back edge of the ditch to facilitate drainage. Mowing height should be 5".
- ② General herbicide treatment is to be confined to an area of approximately 30 feet in width from the edge of all roadways, where right-of-way is available, or to the back of the required drainage channel to insure proper drainage. Spot treatment is allowable beyond this area to eliminate weed species. Avoid spraying wildflowers and other desirable vegetation. Refer to general condition 1-12 and herbicide chapter for additional information.
- ③ Native shrubs may be allowed to revegetate to a distance of 30' from the edge of the roadway.
- ④ Native trees, which will attain a trunk diameter of 4" or greater, may be allowed to revegetate to a distance of 40' from the edge of the roadway.
- ⑤ Wildflower areas - Do not mow until wildflowers have gone to seed. Refer to wildflower chapter for additional information.
- ⑥ Area of natural revegetation - Do not mow in this area.
- ⑦ Mow entire mowable area of the right-of-way annually in late October and November after the wildflowers have bloomed and the seeds have set.

TYPICAL VEGETATION MANAGEMENT SECTION RURAL, SECONDARY and FARM to MARKET

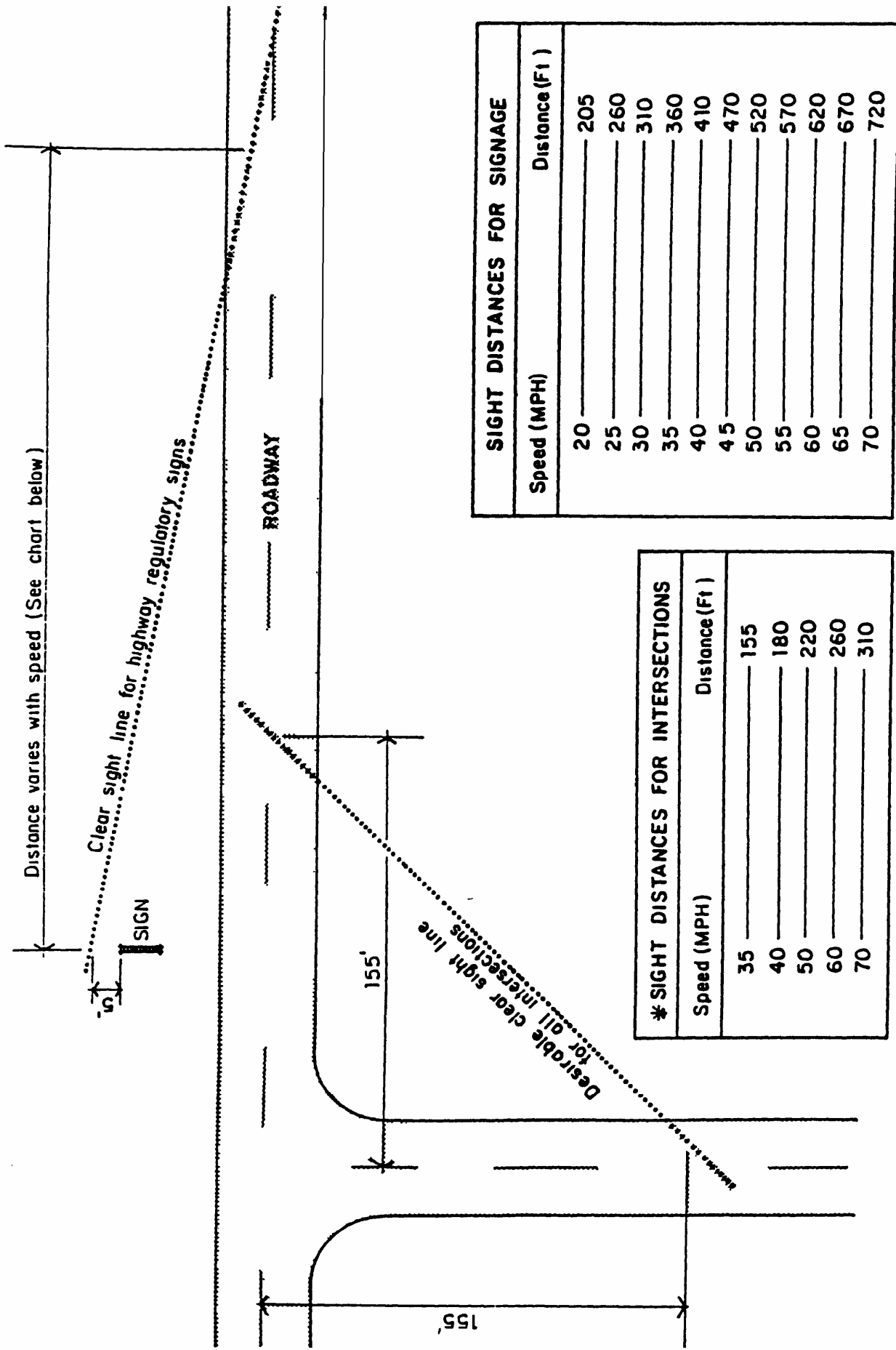

* Right of Way Permitting

SIGHT DISTANCES FOR SIGNS and INTERSECTIONS

HERBICIDES

LAWS AND REGULATIONS

The Federal Insecticide and Rodenticide Act as amended in 1972 (FIFRA) requires individuals who apply restricted use pesticides to be certified applicators. National standards for the certification of applicators are found in Title 40, Part 171 of the Code of Federal Regulations. State standards for certification of applicators are found in the Louisiana Pesticide Law, Chapter 21 of Title 3 of the Louisiana Revised Statutes, Rules and Regulations promulgated under the authority of the Louisiana Pesticide Law have been published in the Louisiana Register further delineating the requirements for certification and recertification. The Louisiana Department of Agriculture has been designated by the U.S. Environmental Protection Agency as the agency responsible for the enforcement of FIFRA within the State of Louisiana. The Department is also responsible for the enforcement of the Louisiana Pesticide Law. The Louisiana Cooperative Extension Service, by cooperative agreement, is responsible for the training necessary to become a certified applicator.

GENERAL

Herbicides have played an important part in the management of the roadside right-of-way the past several years, particularly the Selective Spraying Program. This program is used predominately to control Johnson grass and other weeds while favoring the growth of Bermuda grass which requires little mowing.

Herbicides have also been used successfully on hard surfaced shoulders, cracks in paved traffic islands and revetments under guardrails, at bridge ends, ditches and other areas which are impossible to mow. Since chemicals that are used as herbicides require that safety precautions are observed, the Roadside Development Coordinator in the District should be in complete charge of their use. The operators on the spray trucks are required to be licensed by the Department of Agriculture. The Roadside Development coordinator is familiar with brand names, different types of chemicals, calibration of the rig, pumps, etc., has been licensed and should be consulted in detail for chemical herbicide work.

In order to realize the maximum output from both mowing and spraying operations, it is important that the Parish Maintenance Superintendent and Roadside Development Coordinator manage these operations together. Correct timing will result in good results and a savings of funds. Two mowings per season and two sprayings per season are generally enough for most roadsides if they are coordinated.

DOTD has been using herbicides for approximately 20 years. The main reason for using herbicides is because it is a safe economical means of controlling vegetation resulting in cost savings for the Department.

FACTORS OF HERBICIDE APPLICATION

1. HERBICIDE TYPES

1. Soil-active (residual) herbicides are active in the soil and stop plant growth of germinated seeds and roots in the following manner. Soil-active herbicides are moved into the root zone by water. The herbicide is absorbed by the root system and translocated throughout the plant affecting plant growth processes. Visual effects should begin to appear in several days. The swiftness of the herbicide action is dependent on soil type, rainfall, plant species and rate of herbicide application. Soil-active herbicides can be applied to the soil in the winter prior to

or shortly after the emergence of vegetation in spring. Vegetation must be present; NEVER apply herbicide to already bare ground.

2. Contact herbicides halt visible plant growth at least for a short time in the following manner. Contact herbicides are absorbed by the foliage and transported throughout the plant, affecting plant growth processes. Several days are usually required for the effects to appear. Some of these herbicides may also have a short period of activity in the soil. Vegetative diversity may require a combination of chemicals to be used if broad-spectrum control is desired.

II. DESIRED VEGETATION CONTROL

1. Bare Ground or Complete Vegetation Control - soil-active herbicide at the proper rate and time will normally provide complete vegetation control. Bare ground vegetation management may be desirable in areas where it can be economically maintained or where plant growth creates fire or other safety hazard or decreases maintenance efficiency. To maintain a bare ground condition after the first year application, spot-treatment may be necessary. Application of an excessive quantity of chemical is not economical and may result in damage to desirable vegetation. This type of treatment should only be used in storage yards.
2. Selective Weeding - Selective weeding is the use of a herbicide or a combination of herbicides for the control of selected species and does not permanently harm desired vegetation. Herbicides used for this type of control may be applied either as a pre-emergence (before plants emerge from seed) or a post-emergence (after plants emerge from seeds) application.
3. Chemical Mowing - This is the practice of using herbicide to control undesirable vegetation in close proximity to valuable plants. This procedure can be used to control vegetation under fences and guardrails, along drainage ditches and in landscaped areas when near desirable vegetation.

III. TYPE AND SPECIES OF PLANTS TO BE CONTROLLED

1. Proper selection of herbicides and their application rates are dependent on the type and species of vegetation to be controlled as well as the condition of the plant. Some plant species are resistant to certain herbicides. The condition of a plant may be either active growth or dormancy. It may be a seedling or a mature plant or it may be budding, leafing, flowering or fruiting. All of these conditions should be considered when deciding where and when to use or not to use herbicides. For example, the best condition to apply a contact herbicide to many plants is when they are about to produce a seed head or fruit (e.g., the "boot" stage of Johnson grass). In general, seedling plants are easier to control than older more established plants. Plants are categorized as either annual, biennial or perennial.

2. Annual and Biennial Plants - These plants originate from seed. Annuals complete their life cycle in one year (seed to seed); biennials require two years to complete their life cycle. A contact treatment is generally sufficient in controlling seedlings. Annual weeds around signs and other appurtenances can be controlled with contact treatment or in combination with a pre-emergence herbicide.
3. Perennial Plants - These plants have an extensive root system and live form year to year. Perennials also produce seeds to ensure survival of their species. Specific herbicides, whether contact or soil active, are usually required for their control.

IV. SOIL TYPE

1. Depending on soil type, the proper application rate yields good vegetation control. Soil-active herbicides are more active in soils that are low in clay or organic matter because of the reduced absorbency of these soils. Therefore, the application rate may be reduced. In soils that are high in clay or organic matter, herbicides adheres to the soil particles and is not available to the roots of the plant. Consequently, the rate of herbicide application may need to be increased. The acidic/alkaline nature of the soil can also affect the performance of a herbicide. For example, in relatively acidic soils, OUST decomposes at a faster rate than it does in more alkaline soils. In loose or sandy soils a soil-active herbicide may move off target easily carried, by either water or wind.

V. WIND VELOCITY

1. Wind will disturb the spray pattern and blow the chemical away from the target area; high winds can blow it several feet away. The wider the pattern the greater the effects of wind distortion. It is best to spray before wind velocity rises. The proper drift control agent will help reduce drift. If wind velocity rises too high, and the pattern cannot be kept on target, then spraying should be discontinued.
2. For purposes of deciding whether to spray and for record-keeping, carry a wind gauge in the spray unit to determine wind speed. Highest winds permissible will be 10 miles per hour.

VI. HUMIDITY

1. Relative humidity is the percentage of moisture in the atmosphere relative to the maximum amount which the atmosphere could hold. Generally, the higher the humidity at the time of application, the more rapid the uptake of contact applied herbicides. However, when humidity is at or approaching 100%, rainfall will most likely occur and the herbicide will be washed from the leaf surface. Consequently, herbicides should not be applied when rainfall is imminent. Conversely, if the humidity is approximately 60% or lower, the longer it may take the herbicide to become active.

VII. RAINFALL

1. Rainfall affects chemical control of vegetation. It is a vehicle for movement of soil-active herbicides into the root zone of plants. Soil-active chemicals must be in solution before they can enter the root system of plants. Excessive water may reach the soil-active herbicide below the root zone of the plant resulting in poor control. Moisture from rainfall, thawing cycles and snow on the ground may prevent the herbicide from entering the soil in sufficient quantities to achieve the desired degree of control. Moreover, excessive rainfall may lead to serious herbicide damage to areas outside of the target area.
2. Do not spray contact herbicides during rainfall or if rainfall is likely to occur within six hours after application. Rain will wash the herbicides off the leaves before it can be absorbed by the plant. After a rain, dust on the leaves will have been washed off and contact herbicides are more easily absorbed by the plant. Allow the foliage time to dry after a rain before spraying since wet foliage may yield poor results.

VII. TEMPERATURE

1. Temperature affects the results of vegetation control with herbicides. Do not use herbicides when the soil is frozen, when rain or snow is falling or when there is snow on the ground. High temperatures during the summer months may cause many plants to become semi-dormant. When this occurs, plants will not absorb herbicides adequately.

IX. WATER QUALITY

1. Use good clean water to mix herbicides, as impurities in the water may deactivate the herbicide. Another reason for using clean water is that sand or clay particles may damage the pump, solenoids and nozzles of the spray rig.

X. MIXING, TIMING AND APPLICATION

1. Mixing and application are to be in conformance with the manufacturers' recommendations. All precautions issued by the manufacturer are to be taken into account and followed.
2. Timing for spraying of herbicides will be coordinated and determined by the Roadside Development District Coordinator and the Parish Maintenance Superintendent.
3. A spraying report, as shown on page 20, is to be filled out by the herbicide applicator when applying herbicides to the roadsides.
4. Following is a chart of herbicides, application rates, times to spray and pertinent comments concerning their uses.

HERBICIDE RATE CHART

Product Name	Acre	& Mix	Per & Tank Oct.	Rate Nov. May Tank Dec.	500 Gal. Jan Comments Gal. Feb.	1,000 March & April
Oust	1 ½ oz.			1 oz. X 2 oz. Oust to be used where		
	2 oz.			24 oz. 48 oz. X 32 oz. 64 oz. X		
<p>Oust is required to be used in Nov. & Dec., 2 oz. to be used in Jan. & Feb. in areas where there is a heavy concentration of Johnson grass, 1 ½ oz. per acre should be used. On moderate stands of Johnson grass, 1 oz. should be used after Johnson grass has almost been eliminated. Oust should not be used where Bahia is predominant.</p>						
2-4-D				2 qt. 8 gal. 16 gal. X X		
Roundup				Pro 1 pt. 2 gal. 4 gal. X		
<p>Combination of 2-4-D and Roundup should be used only in southern part of state where 2-4-D is not restricted and when temperature reaches 75 degree or above. Can be used around signs and guardrails at rate of 2 qt. 2-4-D and 1 qt. Roundup per acre. DO NOT SPRAY THIS RATE ON SLOPES.</p>						
Garlon 3A				1 qt. 4 gal. 8 gal. X X		Only to
Roundup Pro				1 pt. 2 gal. 4 gal.		state
<p>where 2-4-D is restricted and when temperature reaches 75 degree or above. Can be used around guardrails and signs at the rate of 1 qt. Garlon and 1 qt. Roundup.</p>						

M.S.M.A.	2 qt.	8 gal.	16 gal.	
		X	X	Only to
2-4-D				be used in southern part of
		2 qt.	8 gal.	16 gal.
				state where 2-4-D is not
				restricted
				and on very rare occasions where
				Roundup will not do as good a
				job and where there is a very thin
				stand on Bermuda grass.
M.S.M.A.	2 qt.	8 gal.	16 gal.	
		X	X	Only to
Garlon 3A				be used in southern part of
	2 qt.	4 gal.	8 gal.	
				state
				where 2-4-D is not restricted
				and on very rare occasions where
				Roundup will not do as good a
				job and where there is a very thin
				stand on Bermuda grass.
Campaign	48 oz.	6 gal.	12 gal.	
		X	X	Can be
				used in southern section
				of state in lieu of 2-4-D and Roundup
				mixture. When heavy concen-
				tration of vines and woody plants
				add 1 pint of 2-4-D.

Product Name	Acre	Mix	Per Tank Oct.	Rate Nov. May Tank Dec.	500 Gal. Jan. Feb.	1,000 Gal. March & April	Comments	
Escort					½ oz.	8 oz.	16 oz.	
						X	X	Can be used where 2-4-D is restricted.
Rodeo	1 qt.				1 pt.	2 gal.	4 gal.	
						X	X	To be used on slopes and in water where Bermuda grass should not be destroyed. To be used under bridges and in water for complete control of vegetation.
			4 gal.			8 gal.		
Roundup					2 qt.	8 gal.	16 gal.	
						X	X	To be used on shoulders, around guardrails and signs when temperature reaches 70 degree or above. Can be used close to trees.
Pro								
Hyvar XL					10 gal.	120 gal	320 gal.	X
								Only to be used in storage yards and in places where complete soil sterilization is required. Can not be sprayed close to trees where there is danger of runoff.
Surfactant					8 oz.	1 gal.	2 gal.	To be used in all tank mixes except OUST alone Hyvar XL or Roundup Pro.
Poly Vinyl					2 oz.	1 qt.	2 qt.	To be used in all tank mixes where fixed booms are used.

Recommended Speed and Pressure on Cibolo	Pressure 28 lbs.	Rate Tank Mix Gal. Per Acre 31.25	Acres 500 Gal. Tank Mix 16 Acres	Acres 1000 Gal. Tank Mix 32
--	------------------	-----------------------------------	----------------------------------	-----------------------------

Sprayers, Guide to Calibration	10 mph			Acres
--------------------------------	--------	--	--	-------

DAILY HERBICIDE SPRAYING REPORT

DISTRICT 05

DATE _____

Parish _____ Route No. _____ Control Section _____ % Complete _____

Location _____

Certified Applicator: _____	<i>Type of Spraying:</i> (check)	<i>Weather:</i>
License No. _____	Contact _____	Sunny _____
Others Worked: _____	Absorbed _____	Partly Cloudy _____
_____	Selective _____	Overcast _____
_____	Root Absorbed Plus Contact _____	Rain _____
_____		Temperature _____
Hours Worked: _____	<i>Wind:</i>	
Truck No. _____	Wind Speed	Wind Direction
Spray Equipment # _____	Shot 1 _____	<i>Soil Moisture:</i>
Pressure _____	Shot 2 _____	Wet _____
GPA _____	Shot 3 _____	Med. _____
	Shot 4 _____	Dry _____

MATERIALS	EPA REGISTRATION NO.	RATE/ACRE	TOTAL USED AT END OF DAY
ARSENAL	242-346		
CAMPAIGN	534-351		
ESCORT	352-439		
FUSILADE DX	10182-367		
GARLON 3A	62719-37		
GARLON 4	62719-40		
HYVAR XL	352-346		
KRENITE S	352-395		
MSMA	19713-42		
OUST	352-401		
RODEO	524-445		
ROUNDUP PRO	524-475		
2,4-D AMINE (RUP)	9779-263		
DRIFT CONTROL			
SURFACTANT			
WATER			
ACRES SPRAYED			

Unusual Observations Along Route:

WILDFLOWERS

GENERAL

Louisiana and DOTD are embarking on a statewide plan for the planting and preservation of wildflowers along its rights-of-way. DOTD and Louisiana Project Wildflower are working very closely evaluating equipment, planting methods and herbicide operations to produce maximum stands of wildflowers.

It shall be the policy of the Department to encourage the growth, planting and preservation of wildflowers in order to provide a natural setting for the traveling public. Mowing and spraying operations shall be coordinated and timed to enhance the wildflower population and provide a naturally appealing roadside appearance.

ESTABLISHMENT OF WILDFLOWER AREAS

One of the best methods of establishing wildflower areas is by observing and documenting native stands in order that they may be preserved for future generations. To this end, a form has been developed in order for the traveling public to report and document any sightings of wildflowers along the state's rights-of-way. These forms will be available in all District offices of DOTD and Louisiana Project Wildflower will distribute these forms at all of their meetings. A copy of this form is attached on page 24.

Another method would be to stockpile topsoil which has wildflower seed present and transport this soil to desired locations. This method allows some seed to remain in place and allows the establishment of new stands in other locations.

Other means of collecting wildflower seed is by cutting the wildflowers with a sickle mower and gathering the cut flowers laden with seed. These cuttings can then be transported to another location and spread thus establishing a new stand of wildflowers.

The method which is being practiced more frequently is by direct planting. Wildflower seeds are being commercially grown and although expensive, they are producing desired results with less effort than other means.

Commercial seed suppliers are able to supply individuals with a mix of several species of seeds or in lots of individual species of seed. Once a selection of types of seed has been determined, it is necessary to establish a planting rate based on the amount of Pure Live Seed (PLS). PLS is the amount of purity multiplied by the percent of germination. The PLS in a lot of seed can be obtained from the supplier. In wildflower planting a rate of 36 to 45 seeds per square yard is normally adequate. Areas that are to be experienced by pedestrians should be planted at a rate possibly 1.5 greater than this. These rates are broad guidelines and should be adjusted to obtain the desired effect. A partial listing of commercial wildflower seed sources is attached on page 26 for informational purposes.

There is a certain amount of risk associated with planting the seed in late fall. Rain and warm temperatures could cause the seed to germinate prematurely and be killed by a freeze.

Site selection is one of the most important factors in establishing new stands of wildflowers. Be sure to establish the site conditions required to grow certain species. Some may require full sun, others partial shade, still others may require constantly moist soil and others well drained soil. Sites that are relatively weed free with existing stands of shorter grass works best. One sloping sites consideration should be given to seeding grass along with the wildflowers. In some cases, it may be necessary to use a fiber mat to hold the soil and seed in place until germination.

Wildflowers have a wide tolerance of soils and PH (Acid/Alkaline) conditions. Wildflowers do best in soils of low fertility. High nitrogen soils only encourage the growth of weeds thus causing competition for growth

and showing of the wildflowers. If a site is void of nutrients, it may be wise to consider the use of a low nitrogen fertilizer such as 5-10-10.

Soil preparation is not absolutely necessary since most wildflower seeds can be broadcast over undisturbed ground. If this method is followed, you can expect some delay in germination and some of the seed can be displaced by the elements or eaten by birds and rodents. The key element in planting wildflower seeds is to have good soil to seed contact.

One method of insuring soil, seed contact is by mowing the area to be planted as close as possible and remove grass clippings and weeds by raking the entire area. Then lightly till the site with a flail motor, roto tiller, harrow, discs or a weighted section of chain link fence pulled behind a tractor. It is important not to till the ground too deep since this will encourage the growth of any weed seed which may be present in the topsoil. A maximum depth of 1/2" is sufficient. In areas which have a strong weed population, it is necessary to treat the unwanted vegetation with a herbicide and removing the dead plants prior to disturbing the ground surface.

The size of the area to be seeded will determine the type of equipment best suited. On small areas hand sowing or a small mechanical device should be sufficient. In large areas mechanical seeders properly calibrated should produce desired results more efficiently and effectively. When planting fine seed, it may be necessary to mix an inert carrier with the seed to obtain better distribution. Recommended inert carriers are sand or vermiculite. The recommended ratio for these carriers is 2:1 sand to seed.

Once the seed has been planted, it must be covered to maximum depth of 1/8 to 1/4 of an inch. This can be accomplished by lightly raking the seed in with a hand rake for small areas, or by using a drag mat behind a tractor for larger areas. If a drill seeder is used, firm the soil after drilling with a cultipacker to insure proper seed/soil contact.

Wildflower seeds need moisture for germination and growth. Supplemental watering may be necessary if there is not adequate rainfall. As the planting becomes established, watering may be reduced. While it is important for the wildflowers to receive water it is equally important to provide adequate drainage for certain species. Germination will vary from species to species and from seed to seed within the same species. Time periods for germination will also vary from as little as several days to as slow as several years.

Once the wildflowers have finished blooming and set seed, the entire area should be mowed. Mowing the area will help to scatter the seed for the following years' growth. Wildflower areas should be mowed to a height of 4"-6" and should be accomplished in October and November. Waiting longer than this to mow generally results in very wet conditions which could cause more harm than good when you attempt to mow.

If a strong weed or invasive grass population has established itself in the wildflower areas, it may be necessary to treat them with a contact herbicide or translocated herbicide to kill the root system in order to give an advantage to the following years stand of wildflowers.

LOUISIANA DOTD WILDFLOWER INVENTORY

DOTD DISTRICT:		* CONTROL SECTION:	
PARISH:		HWY. ROUTE NO.:	
MILEPOST FROM:	TO:	ACRES:	
PLANTED:		DATE PLANTED:	
NATURAL:		DATE REPORTED:	
FLOWER TYPES (COMMON AND SCIENTIFIC)			
LOCATION DESCRIPTION (USE ANY LANDMARKS AND INCLUDE WHICH SIDE OF THE HIGHWAY HAS THE WILDFLOWERS)			
SKETCH AVAILABLE (YES/NO):			
SPONSOR		REPORTED BY	
NAME:		NAME:	
ADDRESS:		ADDRESS:	
CITY, ZIP:		CITY, ZIP:	
PHONE:		PHONE:	

* INFORMATION MAY BE OBTAINED FROM RESPECTIVE DISTRICT OFFICES

PLEASE RETURN COMPLETE FORMS TO: DOTD MAINT. ENGINEERING ADMINISTRATOR
 LA. DEPT. OF TRANSPORTATION & DEVELOPMENT
 P.O. BOX 94245
 BATON ROUGE, LA. 70804-9245

M15-I

**DEPARTMENT OF TRANSPORTATION AND DEVELOPMENT
 ROSTER OF OFFICIALS
 JULY 1999**

<u>DISTRICT</u>	<u>DISTRICT/SECTION HEAD</u> <u>TELEPHONE NO.</u>
02 DISTRICT ENGINEER ADMINISTRATOR P. O. BOX 9180 BRIDGE CITY, LA 70096	MR. JOHN E. EVANCO 225- 893-1549
03 DISTRICT ENGINEER ADMINISTRATOR P. O. BOX 3648 LAFAYETTE, LA 70502	MR. WILLIAM FONTENOT, JR. 318- 826-7678
04 DISTRICT ENGINEER ADMINISTRATOR P. O. BOX.38 SHREVEPORT, LA 71161	MR. BRUCE EASTERLY 318- 797-6743
05 DISTRICT ENGINEER ADMINISTRATOR P. O. BOX 4068 MONROE, LA 71211	MR. JAMES W. FORREST 318- 435-5116
07 DISTRICT ENGINEER ADMINISTRATOR P. O. BOX 1430 LAKE CHARLES, la 70602	MR. JOHN W. "CHIEF" ANDRUS 318-783-1683
08 DISTRICT ENGINEER ADMINISTRATOR P. O. BOX 872 ALEXANDRIA, LA 71309	MR. WAYNE MARCHAND 318- 876-3750
58 DISTRICT ENGINEER ADMINISTRATOR P. O. BOX 110 CHASE, LA 71324	MR. DONALD L. TOLAR 318- 343-2399

61

DISTRICT ENGINEER ADMINISTRATOR
P. O. BOX 831
BATON ROUGE, LA 70821

MR. GORDON NELSON
225-
928-5829

62

DISTRICT ENGINEER ADMINISTRATOR
685 N. MORRISON BOULEVARD
HAMMOND, LA 70401

MR. ROBERT ROTH
225-
345-6780

WILDFLOWER SEED PRODUCERS

FIRM

ADDRESS

PHONE

NATIONAL WILDFLOWER

2600 FM 973 NORTH
512-929-3600

RESEARCH CENTER

AUSTIN, TX 78725

WILDSEED, INC.

P. O.
BOX 3000
800-848-0078

FREDRICKSBURG, TX 78624

WHITE SWAN, LTD.

8030 S.W.
NIMBUS
800-233-7926

BEAVERTON, OR 97008

APPLEWOOD SEED CO.

5310 VIVIAN
ST.
303-431-7333

ARVADA, CO 80002

ERNST CONSERVATION

9006 MERCER
PIKE

SEED

800-873-3321
MEADVILLE, CA 96335

WILDFLOWERS INT'L

918 Enterprise
Way
707-253-0570

NAPA, CA 94558

S&S SEEDS

P. O. BOX 1275
805-
684-0436

CARPINTERIA, CA 93013

STOCK SEED FARMS, INC.

MURDOCK, NE 68407

RR #1, BOX 112
402-867-3771

HARRIS MORAN SEED CO.

HAYWARD, CA 94545

26239 EXECUTIVE
PLACE 415-
785-8880

MOON MOUNTAIN

WILDFLOWERS

MORRO BAY, CA 93442

BOX 34 P. O.
805-772-2473

NOTE: This list is a sample of wildflower seed producers. Other wildflower seed producers not on the list may be used.

LANDSCAPING

GENERAL

Highway landscape design should begin with an analysis and the inventory of the landscape features in order to identify, evaluate and locate the features to be conserved, further developed and/or incorporated in the highway corridor.

Careful and proper landscaping of the right-of-way should result in the conservation, enhancement and effective display of the urban and rural countryside through which the highway passes. A properly landscaped highway will conserve the historical features and natural landscape assets while improving the aesthetic and functional quality of the highway.

There are two general classes of vegetation along highways: turf such as grasses and legumes and the taller growing types consisting primarily of woody plants which are shrubs and trees. This section is devoted to the planning and design of the taller growing plants as seen against the foundation of turf. Woody plants create a three-dimensional effect in the landscape and require special design considerations. Natural growth that exists may provide part or all of the desired planting effects in rural areas. Where possible, the retention of desirable natural existing growth is extremely important and requires consideration early in design. Planting is important along highways on new location and many times it may be more important along reconstructed highways on existing location because of restricted right-of-way and adjacent development.¹

The motorist should be able to view complete vistas and changing scenes in scale with the travel speed. Widely spaced plantings of individual trees or shrubs create a spotty and disturbing effect. Massed plantings are the form and texture of the landscape viewed at highway speeds. Tree plantings should be set back from the traveled lanes, not only for safety but also to insure spatial continuity and the strong visual effect of a wide turf area between pavement and plantings. Generous sight distance must be maintained at all times. The plants used must be capable of growing relatively well with minimum maintenance to serve their purpose under the highway conditions they may encounter.²

Design and choice of plant materials vary considerably from region to region. Rural locations may only require supplementing existing growth with small sized new plants and planting for special functions while the urban and suburban highway may require extensive plantings with larger sized plants.

Planting designs should be created in accordance with the requirements of the highway and serve a justifiable purpose. They should be planned objectively on a broad scale before consideration is given to the actual selection of plants to be used. Their composition should be pleasing and coordinated with the total highway environment with safety being the most important consideration.

¹ Page 69 - A Guide for Transportation Landscape and Environmental Design

² Pages 69 and 70 - A Guide for Transportation Landscape and Environmental Design

Planting plans should be clear, concise, easily understood and presented on drawings separate from the highway construction plans. The plans should indicate type of adjacent land use, topographic features, such as slope limits and utility installations in addition to the location of plants and their area of occupancy at maturity. A plant list should also be included in the plans. This will provide information concerning the species, size, condition, fertilizing requirements and other pertinent general notes which may apply. The latest and best planting techniques should be used along with top quality plants. Specifications for nursery stock, planting and other types of landscape construction should be clear, concise and describe the quality of work desired.³

FUNCTIONS OF HIGHWAY PLANTING DESIGN

In design form follows function. Some functions of highway planting design are as follows:

1. PLANTING FOR HIGHWAY SAFETY

A. Screening Headlight Glare

Plantings can be very effective in screening headlight glare from oncoming vehicles. Blinding vision due to headlight glare can be a cause of accidents. In addition to curved median areas, headlight glare can also be a problem between interchange loops and from frontage roads, service roads and parking areas.⁴ Shrub plantings may help prevent head-on collisions in these conditions.

B. Delineation

Plants may be used to delineate changes in highway alignment. Headlight glare reduction plantings may serve a dual purpose in this regard. Shrubs or trees on the outside of curves may aid in directing a motorist, particularly in fog or rain storms and during night driving. Plants may also be used to aid a motorist in seeing directional signs by framing⁵ or forming a background.

³ Page 70 - A Guide for Transportation Landscape and Environmental Design

⁴ Page 70 - A Guide for Transportation Landscape and Environmental Design

⁵ Page 71 - A Guide for Transportation Landscape and Environmental Design

C. Psychological Design Considerations

Existing and new plantings may help to alleviate driver fatigue brought about by long stretches of riding surface that call for no change of eye focus which may even lull the driver to sleep. Emphasis may be given to directional changes by delineation plantings which aid in a driver's decision by making it easier to discern the outline of a curved roadway. These plantings may be in the median or on the outside of curves. This may be of particular importance at night when the plants are illuminated by headlights. Plantings placed beyond the junction of a "T" intersection may aid in informing a motorist of a change in direction. High headed trees may be placed within an interchange to make it conspicuous in the landscape for approaching roadways. The steepness of a cut slope may be accentuated by using vertical plant forms or minimized by using horizontal plant forms and patterns.⁶

D. No vegetation shall be planted that will hide or obscure visibility of any official highway sign.

2. **PLANTING FOR ENVIRONMENTAL MITIGATION**

A. Traffic Noise

Traffic noise is a serious environmental problem to people living adjacent to major highways carrying large volume of traffic. Plants absorb and scatter sound waves to a small degree. The effectiveness of plants as noise barriers is very limited because of the considerable width, height and density required. The principle noise reduction effect of plantings is psychological. When it is possible or feasible to use barriers or other actual means of attenuation, plantings may reduce human annoyance and awareness of the problem by screening the noise source from view.

Evergreens are best suited for this purpose; however, they may be used in combination with dense deciduous plants. Planting should be an integral part of noise barrier design due to their length and height. Plants can visually soften their effect and reduce the perceived massiveness of the barriers. In addition to trees and shrubs, vines are very effective for this purpose.⁷

⁶ Pages 71 and 72 - A Guide for Transportation Landscape and Environmental Design

⁷ Page 72 - A Guide for Transportation Landscape and Environmental Design

B. Wildlife Habitat

Roadside plantings can provide food in the form of berries, browse and forage. Nesting cover is also provided for birds and other mammals. Preservation of existing trees and shrubs is important and the regeneration of native growth can be hastened by the establishment of mowing limits.⁸

C. Reservation

Where climatic and soil conditions permit, all exposed soil surfaces should be revegetated. This may be in the form of turf, herbaceous or woody vegetation. Through the establishment of mowing limits, regeneration of native growth from adjacent seed sources will be encouraged and a natural blending with surrounding areas will occur. This form of naturalization may be hastened and supplemented by the planting of young trees and shrubs and proper maintenance activities. When reconstruction of a highway occurs, tree and shrub restoration should be included in the landscape plans to serve plant functions wherever this is feasible. This is important where existing roadside buffers must be destroyed for roadway construction.⁹

3. PLANTING FOR AESTHETICS

A. Visual Quality

Planting is one of the several methods used to improve visual quality in transportation facilities. Through the application of landscape design principles, the functional and aesthetic can blend to produce safe and pleasant highways. The highway should reflect the character of attractive communities. Trees and shrubs can provide a green buffer between the traveled way and adjacent development. Plants of larger size may be necessary in urban areas to give an immediate effect. The selection of suitable species is important in urban areas and should be based on experience in similar areas. Street tree plantings can significantly improve the visual quality of communities. Flowering trees and shrubs and wildflowers enhance the highway environment and offer pleasant and changing scenes for the motorist and adjacent property owners.¹⁰

B. Screening Undesirable Views and Objects

⁸ Page 72 - A Guide for Transportation Landscape and Environmental Design

⁹ Page 73 - A Guide for Transportation Landscape and Environmental Design

¹⁰ Pages 73 and 74 - A Guide for Transportation Landscape and Environmental Design

Screening undesirable views seen from and toward the highway can be performed with plants, earth berms, fences and combinations thereof. Space permitting, plantings offer a variety of forms and combinations which can be arranged to obtain the desired results. Although effective screening with plants may take several years to achieve, this should not deter or discourage the use of this method. Sight lines from and toward the highway of the object to be screened should be studied and a determination of the type of screening to be used should be made. Where a year-round effect is desired, evergreen plants should dominate and deciduous should be added for seasonal and textural interest. Whenever possible, consideration should be given to the removal of the objectionable object.¹¹

4. **SETBACK DISTANCES FOR TREES**

These guidelines may be applied to new plantings of trees whose trunk diameter at maturity will be 4 inches or greater. Setback distances or vehicle recovery areas are related to type of slope, slope ratio, traffic volumes and design speed of the highway. The setback is from the traveled way which is the portion of the roadway for the movement of vehicles, exclusive of shoulders and auxiliary lanes. Minimum horizontal and vertical clearance setbacks for all roads will be governed by the Louisiana Department of Transportation Design Standards, found at the end of this section.

Given distances will not always be practical. Variations in site-specific conditions need to be considered and may warrant special treatment. Existing historic, aesthetic or environmentally important trees may be retained within the recovery area if they are protected or are not in a target position, such as the outside of horizontal curves. Shrubs and ground cover may be planted within the recovery area for safety and aesthetic purposes.

The above guidelines should be used unless one of the following reasons will allow for a lesser distance or require a greater distance:

- For central business districts and local streets with barrier curbs, a minimum distance of 1.5 feet should be provided beyond the face of the curb to the anticipated outside diameter of the tree trunk when mature. On urban arterials and collectors with similar curbs and usually higher speeds, the offset distances should be increased.

¹¹ Page 74 - A Guide for Transportation Landscape and Environmental Design

- Where limited right-of-way or the necessity for planting would result in less clearance, all factors in the area should be weighted to decide if a special exception is warranted. Special exceptions or conditions may include:
 1. Where exceptional or unique trees because of size, species or historic value exist.
 2. On designated scenic roads or low-speed roads, as well as low-speed urban roads.
 3. Where the absence or removal of trees would adversely affect rare/endangered/threatened species (plant or animal), wetlands, water quality or result in serious erosion/sedimentation effects.
 4. Locations where the cumulative loss of trees would result in a significant adverse change in character of the roadside landscape.
 5. Landscape, park, recreation, horticultural, residential or similar areas where trees and other forms of vegetation provide significant functional and/or aesthetic value.

- Trees should not be placed or remain where they are particularly vulnerable to vehicle contact or where significant incidences of run-off road accidents occur.

CRITERIA FOR LANDSCAPING INTERSTATE AND MAJOR PRIMARY ROUTES

1. The clear distance from the edge of the traveled way to the face of the tree line shall be a minimum of 50 feet on the mainline and 30 feet for ramps. The setback is measured from the traveled way which is the portion of the roadway for the movement of vehicles, exclusive of shoulders and auxiliary lanes. These distances apply to trees whose trunk diameter will be four inches or greater at maturity.
2. Trees may be planted or remain within the 50 foot clear distance or the 30 foot clear ramp area when they are protected by guardrail on nontraversable backslopes or other protected areas. Setback distances behind guardrails are as follows:
 - A. The minimum distance behind guardrail depends on the deflection of the guardrail as described in the AASHTO reference cited. Examples of this setback distance are 11 feet for cable guardrail, 3 feet for W-Beam guardrail and no distance for concrete barriers.

- B. Although there is no minimum distance behind rigid barriers, consideration should be given to tree branching and maintenance in determining setbacks.
3. The clear distance from the edge of the travel lane to the shrubbery line shall be determined by Sheet 1 of 4 of the Design Standards.
 4. Exit gore areas shall be free for a distance of 350 feet of trees and shrubbery which will attain a height greater than 2.5 feet. Shrubby which will not attain a height of 2.5 feet will be permitted in the gore area. In rural areas, exit gores shall be free of trees for a distance of 600 feet along the mainline and 500 feet along the ramp.
 5. Entrance ramps shall require a minimum of 350 feet along the ramp (sight triangle to the main roadway) free of trees and shrubbery. In the case of loop ramps, a point 350 feet from the gore area, intersecting the main travel lane and extended to the nose of the off ramp preceding the loop or 600 feet (whichever is longer) shall be clear of trees and shrubbery, with the exception of shrubs which will not attain a height greater than 2.5 feet. In the case of large rural diamond interchanges, there will be no planting over 2.5 feet in height along a line of sight from a point 500 feet from the gore area intersecting the mainline and a point 600 feet along the mainline from the gore area.
 6. The clear distance from the edge of ramps to the shrubbery line shall be a minimum distance of 15 feet.
 7. The clear distance from the edge of entrance and exit ramps to the tree line shall be a minimum of 50 feet. No trees will be permitted within 50 feet of the inside and outside edge of a loop ramp. Shrubby may be planted in front of any group of trees planted outside the 50 foot line. Shrubby planted within the 30 foot line on the inside of loop ramps shall not attain a height greater than 2.5 feet in order to provide adequate stopping sight distance around the loop.
 8. Ramp terminals at the crossroads shall have an unobstructed view of the crossroad for a minimum of 150 feet in all directions. The view back beyond the structure from the exit ramp intersection with the crossroad shall be kept unobstructed within the limits set by the columns or embankment.
 9. No trees shall be planted within utility rights-of-way or in areas which may interfere with power lines once the trees mature.
 10. Refer to pages 41-43 for graphic illustrations of these criteria.

11. Design Guidelines may be loosened so as to permit maintenance - intensive designs which might not otherwise be permitted on the state highway system. Examples might include fountains, statuary and/or planting schemes which require a high level of consistent maintenance in order to assure success.

CRITERIA FOR LANDSCAPING ARTERIAL ROADS, COLLECTOR ROADS, LOCAL ROADS AND STREETS

1. The normal setback distance for trees (See Design Standards for Urban UA-1, UA-2) whose trunk diameter at maturity will exceed four inches shall not be closer than 40 feet from the travel edge of the roadway except in special conditions:
 - A. On the high or cut side of the roadway not in the likely path of an uncontrolled vehicle.
 - B. On the low or fill side if protected by a guardrail or not likely to be hazardous to an out of control vehicle.
 - C. If important historically or aesthetically and protected by a guardrail.
 - D. On routes in cities and towns with speed limits 45 mph or less, a minimum of 10 feet behind a barrier curb to the face of the tree. Trees of this size will only be allowed in medians which are 30 feet or greater in width and protected by a barrier curb.
2. Small trees, with trunks normally less than 4 inches, such as crape myrtle, wax myrtle, etc., will be allowed in medians, on routes with speed limits up to 45 mph, under the following conditions:
 - A. Minimum setback determined by design standards behind a barrier curb. Not more than 4 feet of the tree spread will be allowed to overhang the roadway.
 - B. A minimum setback of 30 feet beyond the edge of the travel way, for uncurbed roadways and medians, providing they do not interfere with the drainage pattern
3. The clear distance from the right edge of the travel way to the shrubbery line shall be a minimum of 25 feet. When protected by a barrier curb, the minimum will be determined by Design Standards.
4. On curves, adequate sight distance for the design speed of the highway must be maintained. (See Design Standards)

5. For safety reasons, control of landscaping at intersections is critical. Sight triangles at intersections are determined by the design speeds of the intersecting roadways. Any object within the sight triangle high enough above the elevation of the adjacent roadways to constitute a sight obstruction will not be allowed. No trees shall be planted in sight triangles. Shrubbery and ground cover will be allowed in the sight triangle providing their height does not exceed 2.5 feet above the roadway surface. Minimum sight distance requirements for intersections are illustrated on page 46.
6. Refer to pages 44-46 for illustrations of these criteria.
7. Design Guidelines may be loosened so as to permit maintenance-intensive designs which might not otherwise be permitted on system. Examples might include fountains, statuary, art and/or planting schemes which would require a high level of consistent maintenance in order to assure success.
8. A plant list outlining various species that have been used for highway planting is included on pages 36-40. This should not be the only plant material considered for highway landscaping.

The Landscape Unit of DOTD will provide technical assistance, standard plans and suggestions for construction methods along highway rights-of-way to local governing bodies. They should address the request to the Secretary of DOTD in order to obtain assistance. Upon completion of the planning and design phase of a project, the governing body, which requested the project will obtain a permit from DOTD's Permit Unit. This permit will stipulate that the governing body will construct and maintain the project at no cost to DOTD.

PLANTING LIST

The following is a listing of plants which have been used on landscaping projects with success. This list is only intended as a guide and is not considered to be all inclusive.

SHRUBS AND GROUND COVERS (30" MAX. HT.)

LIRIOPE (Liriope Muscari or Liriope Spicata)

MONKEY GRASS (Ophiopogon Japonicum)

ASIAN JASMINE (Trachelosperum Asiaticum)

DAYLILLY (Hemerocalis Spp.)

INDIANA HAWTHORNE "Clara" (Raphiolepis Indica)

"BLUE RUG" JUNIPER (Juniperus Horizontalis "Wiltonii")

"BLUE PACIFIC" JUNIPER (Juniperus Conferta "Blue Pacific")

"PARSON'S JUNIPER (Juniperus Parsoni)

SMALL SHRUBS (4' MAX HT.)

DWARF YAUPON (Ilex Vomitoria Nana)

DWARF CHINESE HOLLY (Ilex Cornuta Rotunda)

INDIANA HAWTHORNE "PEGGY" and "JANICE" (Raphiolepis Indica)

COMPACTA JUNIPER (Juniperus Chinensis Pfitzeriana Compacta)

* DWARF OLEANDER "PETITE PINK" or "PETITE SALMON"
(Nerium Oleander)

FOUNTAIN GRASS (Pennisetum Setaceum)

MAIDEN GRASS (Miscanthus Sinensis)

*These plants should be used in only the southern most areas of the state due to their susceptibility to freezing.

LARGE SHRUBS

PAMPAS GRASS (Cortaderia Argentea)

ELEAGNUS (Eleagnus Angustifolia)

*PITTOSPORUM (Pittosporum Tobira)

*OLEANDER (Nerium Oleander)

SPIRAEA (Spiraea Reevesiana)

*PRIMROSE JASMINE (*Jasminum Primulinum*)

LIGUSTRUM (*Ligustrum Japonica*)

*VIBURNUM (*Viburnum Odoratissimum*)

PHOTINIA (*Photinia Fraseri*)

PINEAPPLE GUAVA (*Feijoa Sellowiana*)

*SAGO PALM (*Cycas Revoluta*)

*These plants should be used only in the southern half of the state due to their susceptibility to freezing.

SMALL TREES (25' MAX. HT.)

CRAPE MYRTLE (*Lagerstroemia Indica* or *Lagerstroemia Indica* x *Fauriel*)

WAX MYRTLE (*Myrica Cerifera*)

LEGGY YAUPON (*Ilex Vomitoria*)

TREE HOLLIES (MANY VARIETIES) (*Ilex*)

LEGGY LIGUSTRUM (*Ligustrum Japonica*)

LEGGY PHOTINIA (*Photinia Fraseri*)

LEGGY PINEAPPLE GUAVA (*Feijoa Sellowiana*)

*LEGGY VIBURNUM (*Viburnum Odoratissimum*)

**CRAB APPLE (*Malus Spp.*)

*VITEX (*Vitex Agnus Castus*)

JAPANESE MAGNOLIA (*Magnolia Soulangeana*)

PURPLE PLUM (*Prunus Cerasifera*)

*WINDMILL PALM (*Trachycarpus Fortunei*)

*PALMS (MANY VARIETIES)

*These plants should be used only in the southern portions of the state due to their susceptibility to freezing.

**These plants should be used only in the northern portions of the state.

MEDIUM TREES

DRAKE'S ELM (*Ulmus Parvifolia Sempervirens* "Drake")

PISTACHIO (*Pistachia Chinensis*)

BRADFORD PEAR (*Pyrus Calleryana* "Bradford")

*GOLDEN RAIN TREE (*Koelreuteria Bipinnata*)

*CABBAGE PALM (*Sabal Palmetto*)

*PALMS (MANY VARIETIES)

* These plants should be used only in the southern portions of the state due to their susceptibility to freezing.

LARGE TREES

LIVE OAK (*Quercus Virginiana*)

SAWTOOTH OAK (*Quercus Acutissima*)

WATER OAK (*Quercus Nigra*)

SHUMARD OAK (*Quercus Shumardii*)

RED MAPLE (*Acer Rubrum Drummondii*)

SILVER MAPLE (*Acer Saccharinum*)

TULIP POPLAR (*Liriodendron Tulipifera*)

AMERICAN ELM (*Ulmus American*)

CEDAR ELM (*Ulmus Crassifolia*)

WINGED ELM (*Ulmus Alata*)

SWEET GUM (*Liquidambar Styraciflua*)

CYPRESS (*Taxodium Distichum*)

SOUTHERN MAGNOLIA (*Magnolia Grandiflora*)

WEeping WILLOW (*Salix Babylonica*)

PINES (MOST VARIETIES) (*Pinus*)

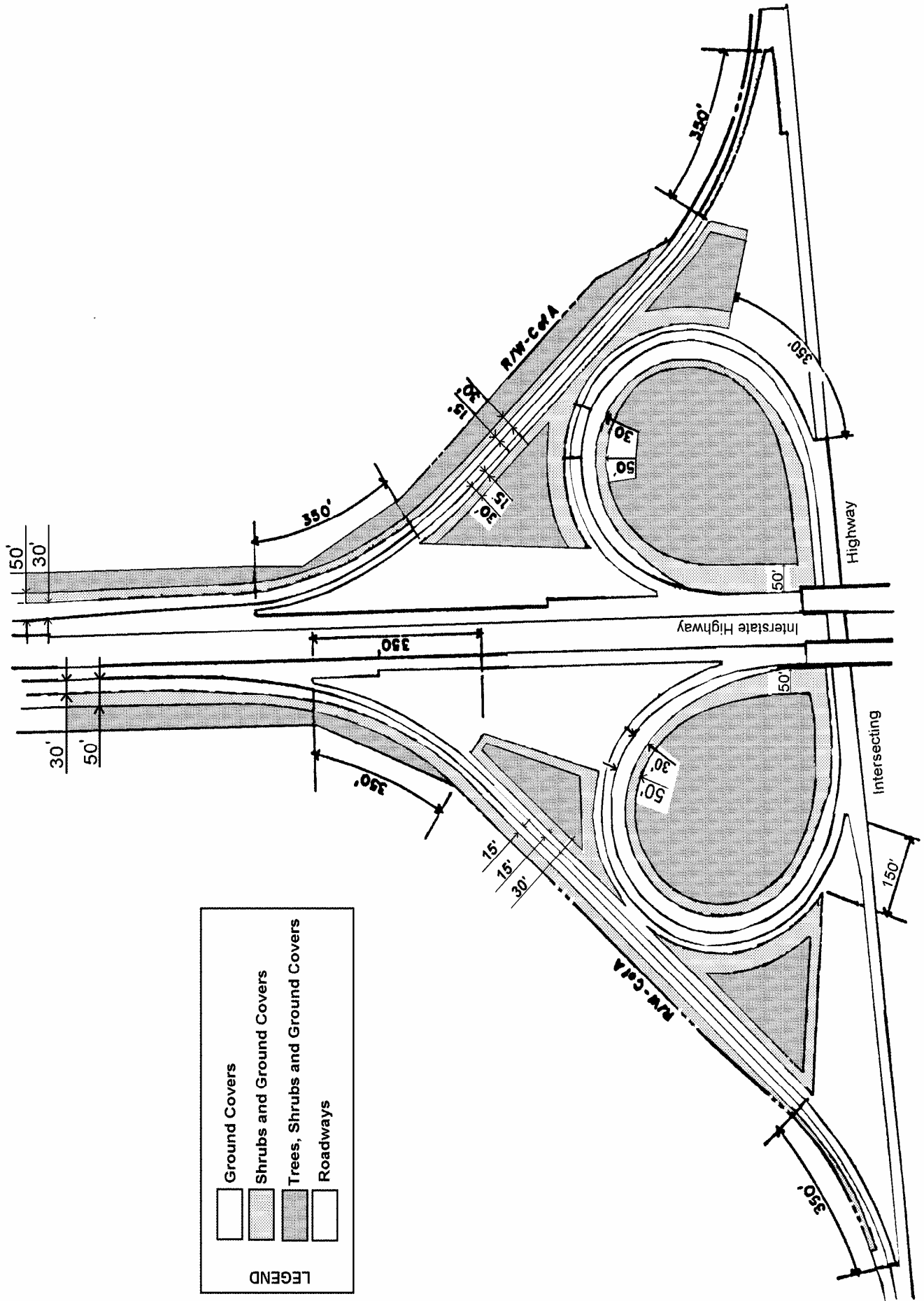

LEGEND

	Ground Covers
	Shrubs and Ground Covers
	Trees, Shrubs and Ground Covers
	Roadways

TYPICAL URBAN CLOVERLEAF

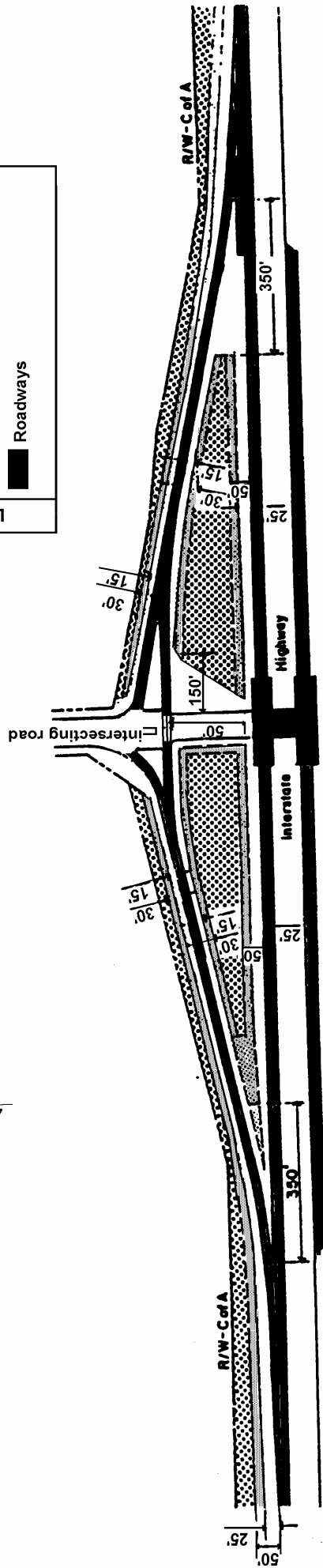
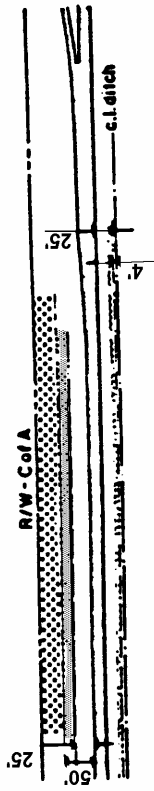
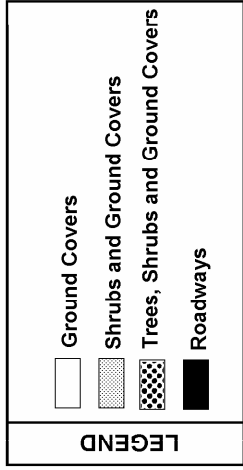

TYPICAL URBAN DIAMOND

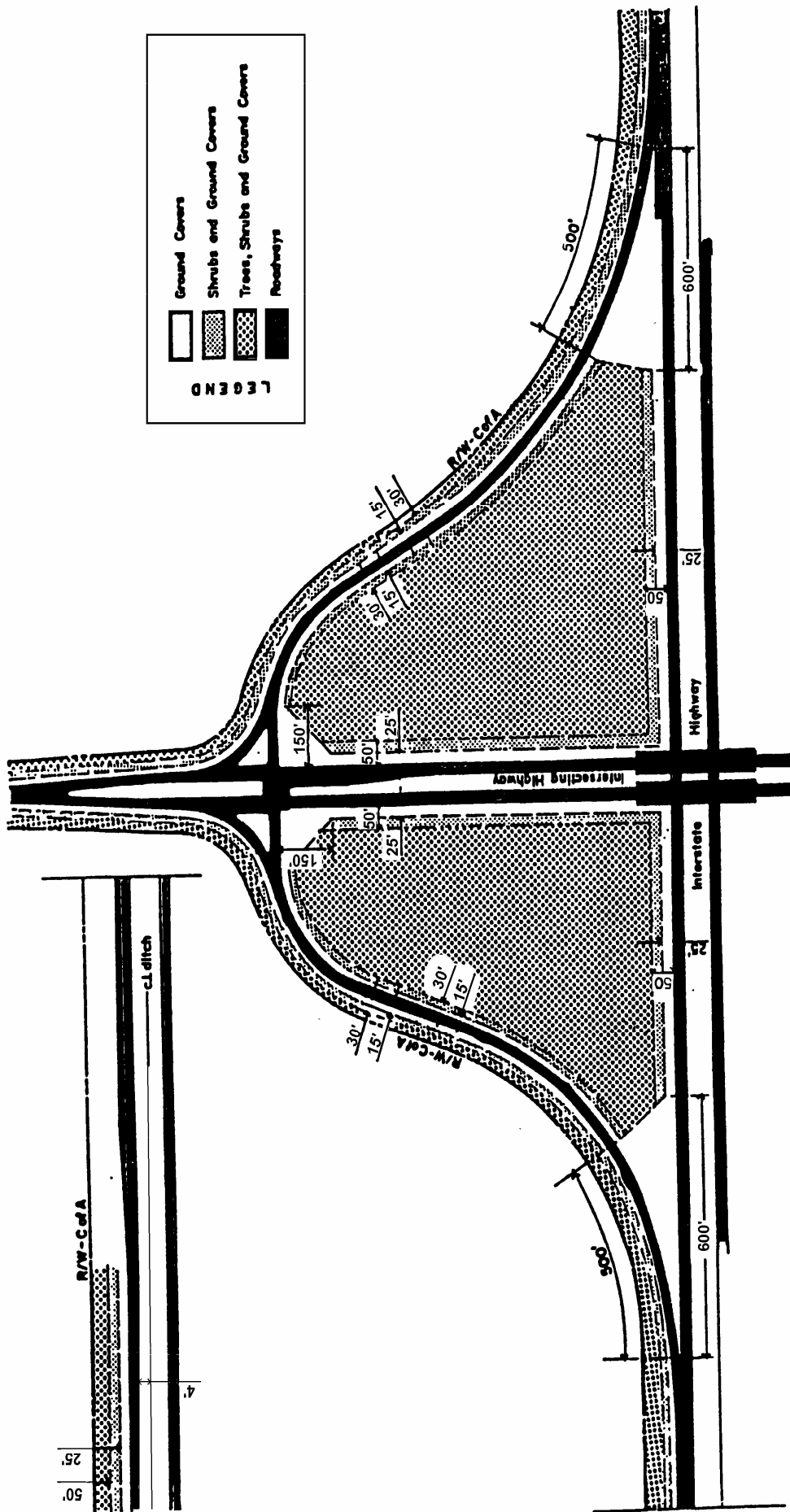

TYPICAL RURAL INTERCHANGE

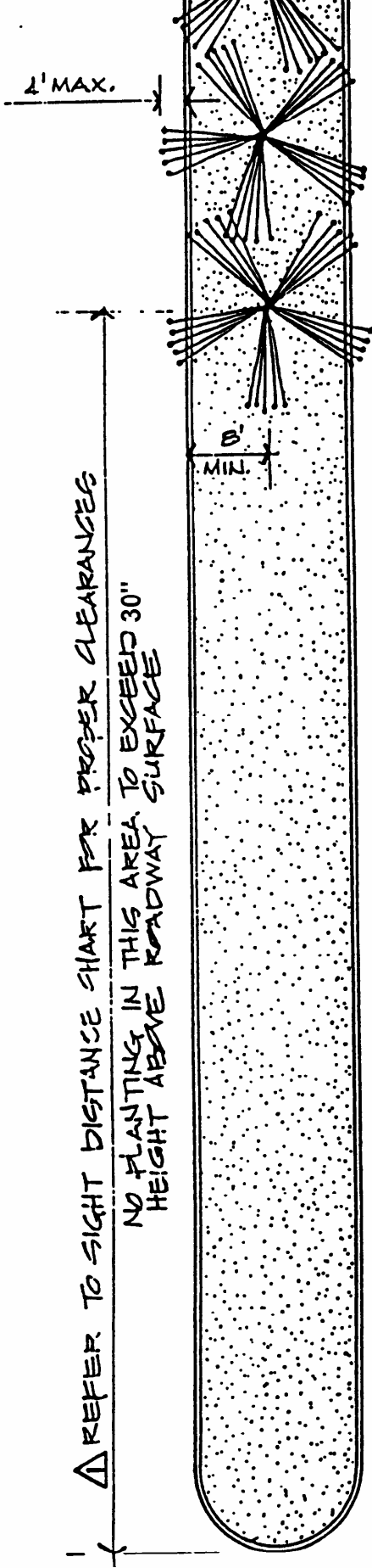

NOTE:

MATURE SPREAD OF TREE CANOPY SHOULD NOT OVERHANG ROADWAY BY MORE THAN 4 FEET AND NOT INTERFERE WITH TRAFFIC.

LARGE TREES SHOULD NOT BE PLANTED IN MEDIANS LESS THAN 40' WIDE WITHOUT CURBS. IN MEDIANS OF LESS THAN 40' WIDTH, EXAMPLES OF ACCEPTABLE TREES ARE GRAPE MYRTLE, WAX MYRTLE, CRAB APPLE, LEGGY LEINSTRUM, ETC. ALONG WITH ALL SHRUBS.

MEDIAN PLANTING FOR BARRIER CURBED ROADWAYS - PRIMARY & SECONDARY ROUTES

- ▲ Revised: 3/22/91
- ▲ Revised: 10/30/98

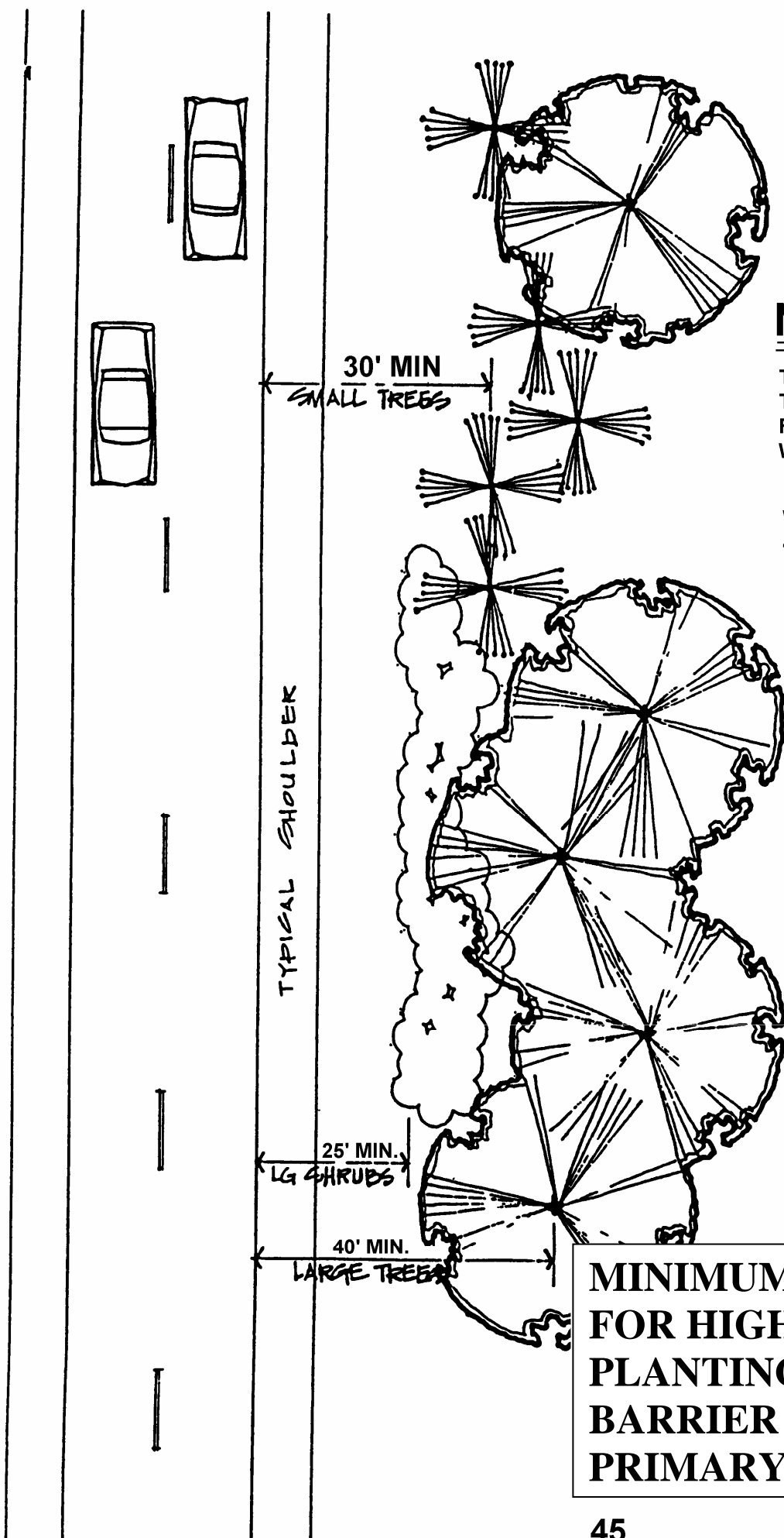

NOTES:

THESE SETBACKS APPLY TO BOTH TWO LANE AND FOUR LANE ROADS WITH UN-CURBED MEDIAN.

LARGE TREES ARE THOSE WHOSE TRUNK EXCEEDS 4" AT MATURITY.

SMALL TREES ARE THOSE WHOSE TRUNKS ARE LESS THAN 4" AT MATURITY

MINIMUM SETBACKS FOR HIGHWAY PLANTINGS WITHOUT BARRIER CURBS FOR PRIMARY AND

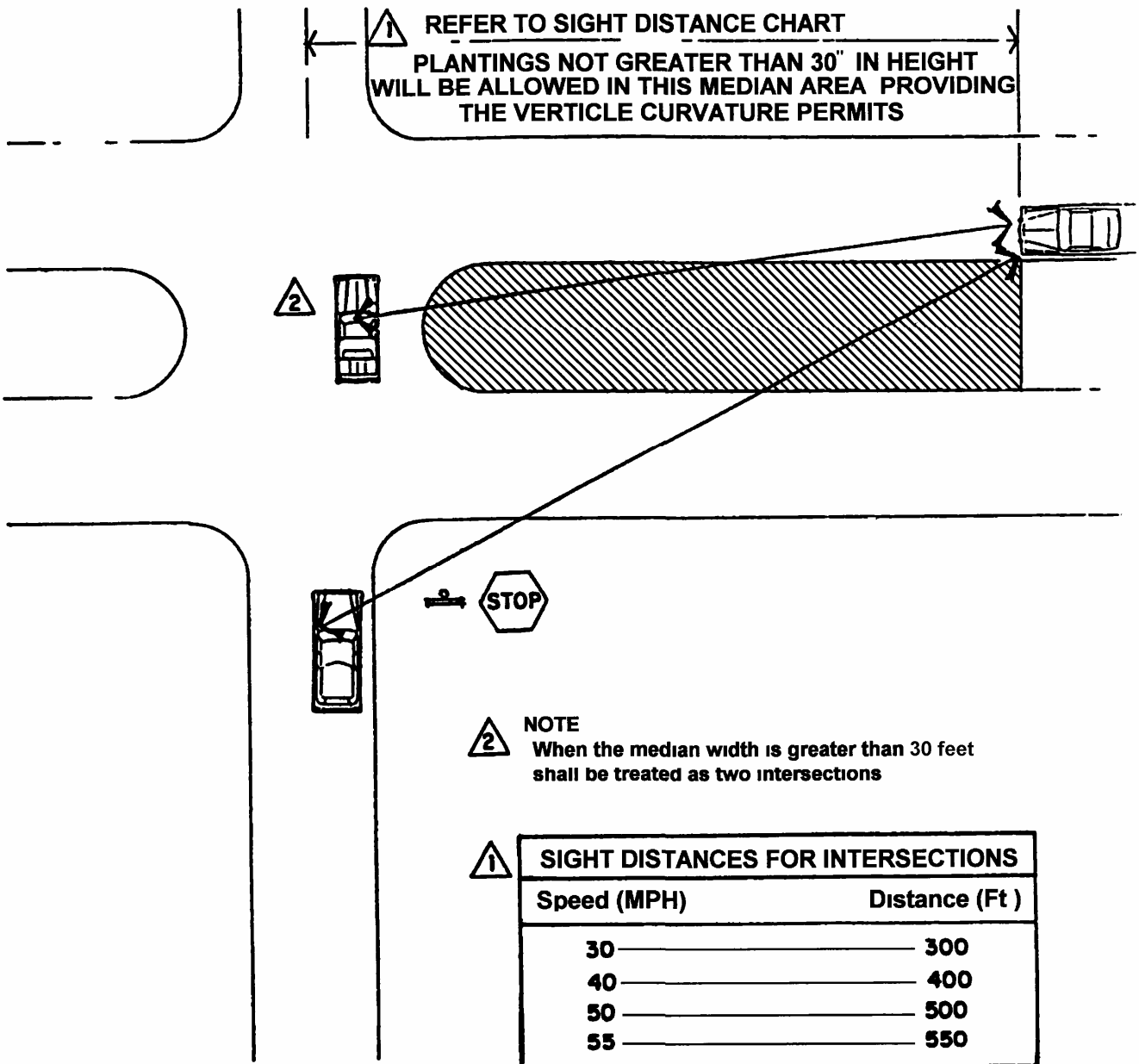

Source - Transportation Engineers Handbook, 1982
 Edition (Table 19-8)

SIGHT DISTANCE REQUIREMENTS AT TYPICAL INTERSECTION DIVIDED HIGHWAY

3 REVISED 10/30/98

CHAPTER 5

GUIDELINES FOR VEGETATION VISIBILITY PERMITS

GENERAL

D.O.T.D. recognizes the presence of vegetation on highway rights-of-way has a positive value for Louisiana. Trees benefit the state by mitigating the impact of our highway system, increasing soil stabilization, provide wildlife habitat, and moderating microclimate extremes. D.O.T.D. endorses the preservation of existing vegetation along transportation corridors. It may be necessary to remove vegetation when maintenance and safety concerns warrant such action.

D.O.T.D. may consider trimming and the removal of vegetation that visually impacts legally permitted outdoor advertising displays and adjacent businesses. This does not mean that all permit requests will be granted. Factors such as adjacent land use visual screening of & from the roadway, tree species types & conditions, and public opinion will be considered before a final determination is made. All permits granted for vegetation removal will require mitigation in the form of replacement plantings. Maintenance of these planting areas will become the responsibility of the permittee. Permits will only be issued between October 15 and April 15 to promote optimum survival of replacement vegetation.

PROCEDURE

Requests for an off-premise or on-premise advertising displays will be made using application for Project Permit Form Nos. DOTD 03-41-3035 or DOTD 03-41-0593, copies of which will be maintained in each district office. The application for a permit shall include the following:

- (1) State or Federal Highway Number
- (2) Location or distance from nearest state highway intersection to the proposed sign location.
- (3) Number, name of species, approximate diameter and height of existing trees which are projected for removal.
- (4) Where trees are in groups, the diameters and heights may be shown for each group as a whole; i.e., 10 oaks and pines 8" to 12" diameter, 30' to 50' high.
- (5) Approximate number and names of shrubs and vines or, if the number cannot be estimated, the distance and location along the highway from point to point must be shown.
- (6) Kind of work to be done - trimming, removal and replacement (replacement will be required in all instances where removal of vegetation is requested). No topping of trees will be allowed.
- (7) 8' x 10' color photographs taken from required locations (see Diagrams 1 & 2) clearly marked to show limits of work.

As part of his review, the traffic operations engineer will verify the location of the display and will forward the request to the Headquarters Permits Unit with information about the displays legal status.

Legal status will include available and pertinent information that should be considered, including but not limited to the following:

- (1) Is this display under active citation?
- (2) Is this display subject to imminent removal?
- (3) Is this display illegally placed?
- (4) Is this display nonconforming to state beautification criteria?

Where replacement of trees is required, a plan (designed by a licensed Landscape Architect, at no cost to the Department) will be submitted to the Department for review, comments and/or approval.

Trimming and removal of trees must be performed by a bonafide bonded tree care service at no cost to the Department. A licensed landscape contractor shall perform replacement to trees at no cost to the Department.

The permit shall contain a warranty clause wherein the permittee agrees to replace any trimmed or replacement tree or vegetation not living or seriously damaged one year after work is completed.

Visibility improvement will not be undertaken in any of the following instances:

- (1) The display has been in place less than five (5) calendar years.
- (2) The display is illegally placed.
- (3) The display is currently under contract with the state to be removed or it will be removed within one year.
- (4) The display is on state property.
- (5) A right-of-way take is imminent within one year.
- (6) The trees or other vegetation to be trimmed, selectively removed, or removed and replaced are a distance greater than 500' measured along the highway from the display.

Access to the work area shall be from private property or frontage road side and not from the main roadway or ramps. Where this is not practical the permittee shall conduct his operation in accordance with DOTD Maintenance Standards including appropriate traffic control devices. The area shall be restored to original condition upon completion of the work.

Drainage shall not be impeded.

Work will be performed only during regular daylight department hours, Monday through Friday excluding legal holidays.

Vegetation which has been cut will not be left overnight within 30 feet of the travel lane or within highway right-of-way, whichever is less. No more vegetation will be cut down than can be cleaned up and removed by the end of work the following day. No debris will be left over a weekend or holiday. No burning will be permitted on the highway right-of-right. Stumps shall be cut or ground flush with the ground and treated with an EPA approved herbicide immediately after the stump is cut.

Work shall not interfere with traffic on the roadway or shoulder at anytime. Parking of vehicles on roadway or shoulder shall not be permitted. All loading, hauling or other work associated with the permit will be conducted across adjacent property. Appropriate warning signs shall be placed by the permittee in advance of the work area in accordance with the current edition of Part VI of the Manual on Uniform Traffic Control Devices (MUTCD) – Standards and Guides for Traffic Controls for Streets and Highway Construction, Maintenance, Utility and Incidental Maintenance Operations.

The vegetation control area will not extend more than 500' along the highway from the viewable face(s) of the advertising device and cleared to and along the line of sight.

Where operations are conducted in an unsatisfactory manner or for any other cause, the Department may revoke the permit and any future permitting will be withheld until the unsatisfactory condition has been corrected.

DIAGRAM I SINGLE FACE SIGN

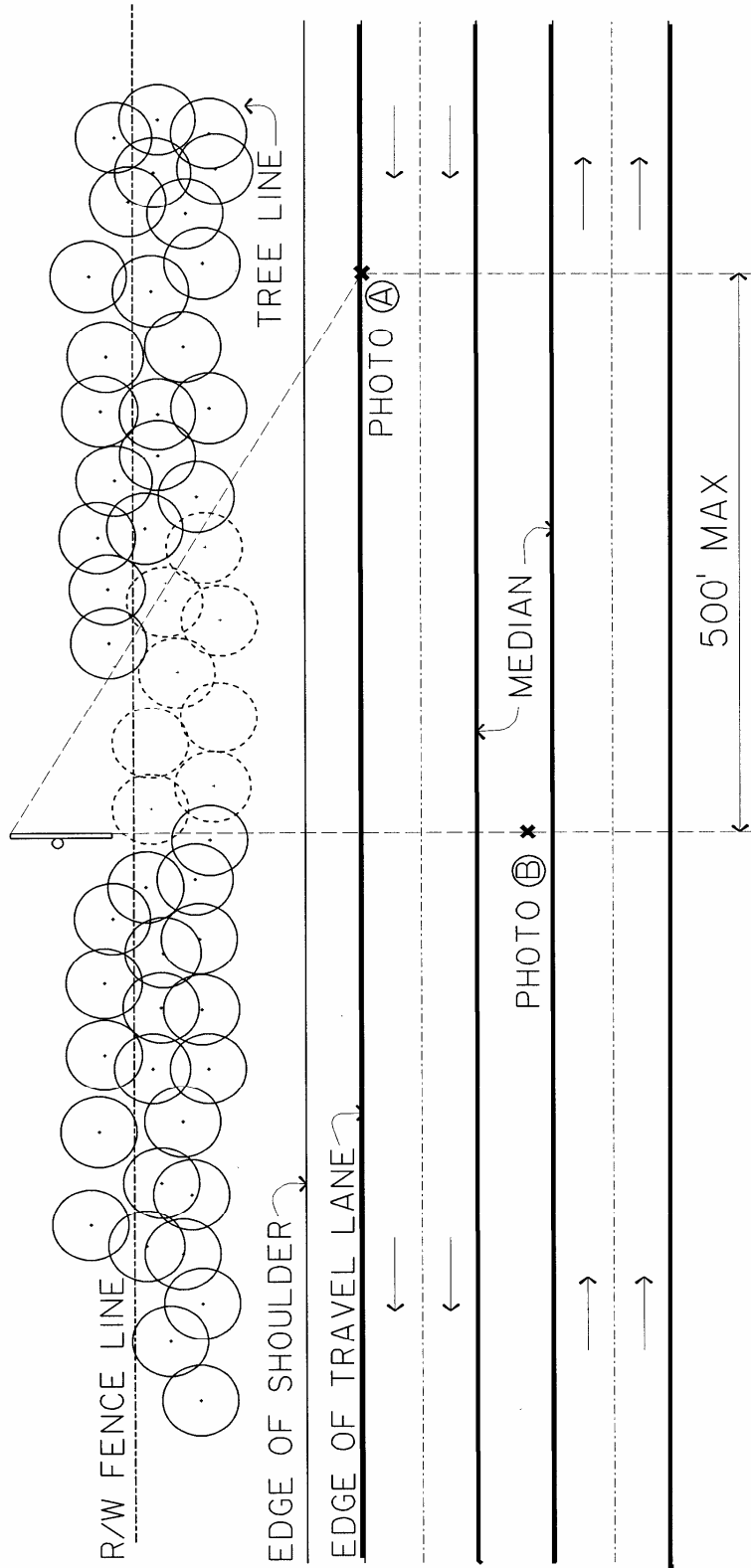
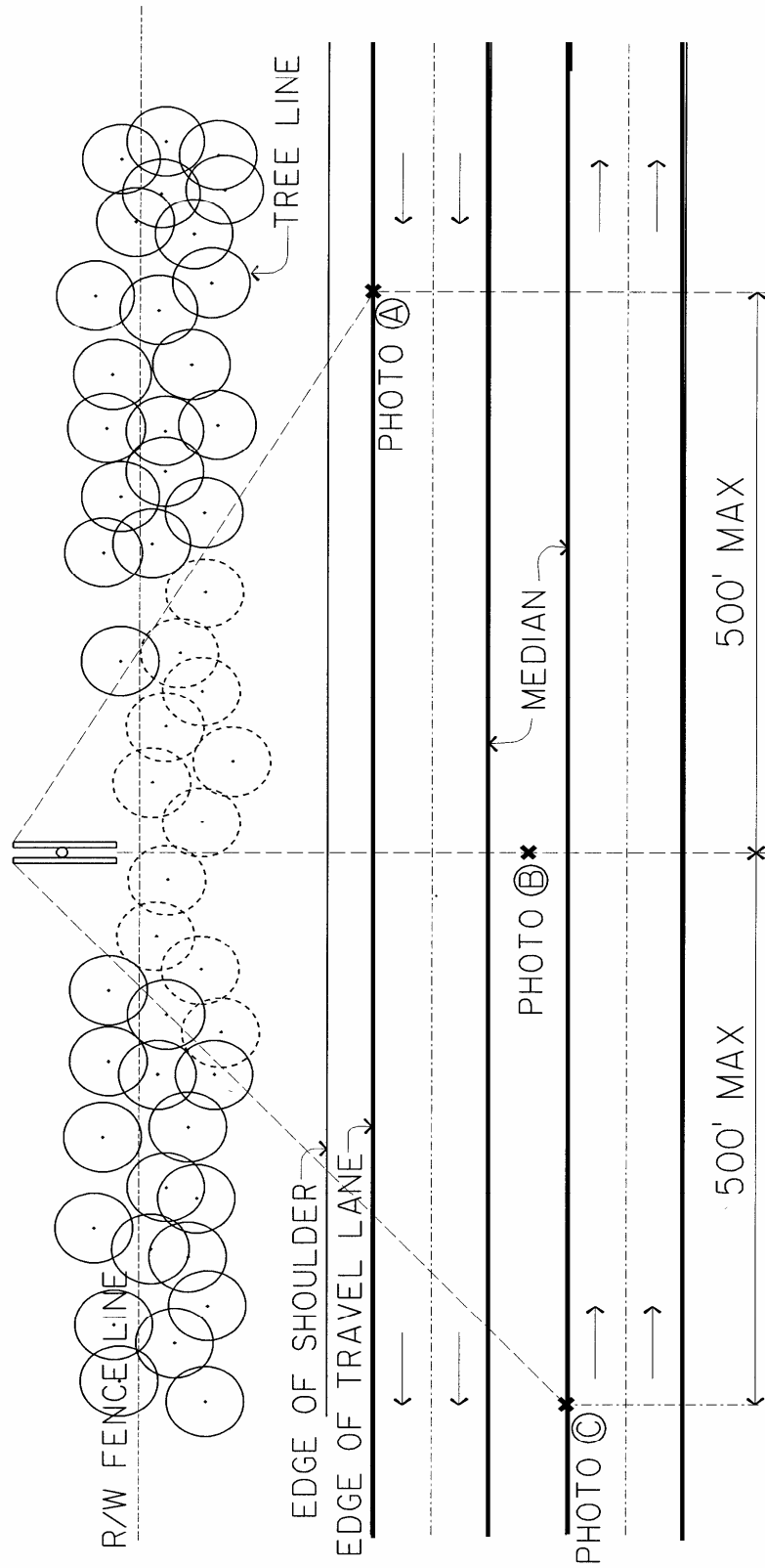

DIAGRAM 2 DOUBLE FACE SIGN



**Louisiana Department of Transportation and Development
Office of Engineering
Engineering Directives and Standards**

EDSM No: I.1.1.21

Subject: TREATMENT OF SIGNIFICANT TREES IN DOTD RIGHT-OF-WAY

Revision Date:

Effective Date: 10/18/99

1. **PURPOSE:** To establish a general policy governing the treatment of existing significant trees within the highway right-of-way, zone of construction or operational influence.
2. **PHILOSOPHY:** Our mission is to design and build highways and transportation facilities for the movement of people and goods, yet which incorporate and accommodate cultural and community values. While emphasizing the importance of safe and efficient transportation systems, we must realize that transportation's value to a society is relative to all other things valued by a society. The unyielding implementation of design and safety standards can cast a highway agency in a very negative light with the public when standards are given blind precedence over local fixtures which the community may hold dear. The same public that demands better and safer roads with increased capacity may also seek to prevent implementation of a demanded highway improvement, when such implementation necessitates the removal of a cherished tree or trees. Our challenge is to find design solutions and operational options that give full consideration to these values, which are often in conflict with traditional transportation design objectives.
3. **LEGISLATION:** Legal basis and mandate for the above philosophy exist at both the federal and the state level. The Intermodal Surface Transportation Efficiency Act (ISTEA) of 1 991 and the National Highway System Designation (NHS) Act of 1 995 both make strong commitment to preserving and protecting the environmental and cultural values affected by transportation facilities. In Louisiana, R.S. 48:267, R.S. 48:268, and R.S. 48:269 address the preservation and encouragement of trees, shrubbery, and vegetation, the tampering with trees and shrubs, and general authority for aesthetics in roadside development.
4. **DEFINITION:** For the purposes of this policy, a tree is significant if it is 18 inches or greater in diameter, or is judged to be viable and aesthetically important by the Department's Landscape Architect, or if it considered significant by one or more members of the local community. (R.S. 3:427 1 requires that any tree "ten inches in diameter breast height or greater" cut down on public land or rights of way be replaced by at least two trees, provided adequate space is available. This policy is intended to accord a higher degree of awareness to the disposition of trees with specific significance to the community).

5. **DESIGN CONSIDERATIONS:** Trees are an important aspect of community identity and may carry a great deal of emotional ties with its members. If communities consider existing trees a valuable resource, alternatives to complete eradication should be pursued. These may include installation of traffic barriers, lowering of the design speed, or even complete redesign of the facility to incorporate the trees. In most cases, a design solution can be found; but, the design team must recognize that individual situations will require individual solutions and individual approaches to design. The proximity of trees to the likely paths of errant drivers is a serious consideration to be made by designers knowledgeable in safety issues. However, a decision to create a clear zone that requires the removal of existing trees is an issue that should be presented to the public and addressed by the multidisciplinary team very early in the design process. The Department's Landscape Architect and Environmental Engineer should be consulted when designs or operations pose potential conflict with significant trees. The fundamental principles to guide the designer, in order of preference, are:

Avoid --All reasonable measures should be considered to avoid conflicts with trees of local value and significance. Such measures are not limited to choices in alignment or cross section features. Selective routing of a storm sewer trunkline may avoid damaging or removing a significant tree, even it requires additional right-of-way or servitude. Placement of a pipe or a utility may be accomplished by boring as opposed to trenching to avoid damage to root systems.

Limit -- When complete avoidance is not possible, all reasonable measures should be taken to limit the magnitude and extent of the disturbance the affected trees. The Department's Landscape Architect should be consulted in developing appropriate limitation measures.

Mitigate -- Plans should include measures to mitigate any necessary impacts to existing significant trees. These may include compensation to landowner, replacement, or enhancement at another valued location. Decisions regarding appropriate mitigation must be made in cooperation with the affected local community or landowner. At the minimum, the mitigation plan must meet the requirements of R.S. 3:4271, which requires the planting of at least two replacement trees for each tree greater than ten inches in diameter removed (provided that appropriate space is available).

References to guide in preliminary design concepts and in specific design solutions include: Flexibility in Highway Design, U.S. Department of Transportation, Federal Highway Administration Publication No. FHWA-PD-97-062, and A Guide for Transportation Landscape and Environmental Design, American Association of State Highway and Transportation Officials, Publication No. ISBN 1-56051-009-0.

6. **REMOVAL :** The decision to remove a significant tree should be reached only after all reasonable efforts to preserve it have been exhausted and will require the concurrence of the Chief Engineer that there are no acceptable design or operational alternatives. In most cases, it is expected that a decision to remove will have been made in a climate of public involvement and dialog with members of the affected community. In no case will a decision to remove a significant tree be implemented without notifying the affected community of the Department's intentions and its reasons.
7. **CONSTRUCTION CONSIDERATIONS:** Trees determined by the design team to be significant and their appropriate disposition (preservation, specified limited impact, or any special treatment) will be identified in the plans. The Project Engineer will assure that the contractor's operations are sensitive to the treatment required by the plans. Construction considerations may include temporary fencing to protect from construction equipment, avoidance of root zones, care of overhanging branches, etc. (there may be need for additional language in Standard Specifications)

8. **MAINTENANCE CONSIDERATIONS:** The same clear zone for which the project was designed and constructed should be maintained free of new growth. The decision to maintain or remove trees within the right of way of an existing system will be governed by the design standards applicable to the original design and construction. Installation of protective measures, such as barrier rail, may be considered. Trees should be trimmed to provide appropriate vertical clearance. The Department's Landscape Architect should be consulted prior to cutting or pruning of any significant trees. All maintenance operations should be conducted with the same care as exercised in construction to avoid damage to existing significant trees.

VISIBILITY MAINTENANCE: Where existing trees or vegetation obscures displays which were lawfully in place prior to the existence of the trees or vegetation, or where displays are erected by permit after existence of trees and/or other vegetation, removal and replacement will be considered as warranted by local conditions and in accordance with Chapter 5 of the Louisiana Department of Transportation and Development Policy for Roadside Vegetation Management.

9. **RETROFITTING FOR NEW DESIGN STANDARDS:** It will be the general policy at DOTD to retrofit new design standards to existing systems only as part of a general upgrade or reconstruction. Otherwise, the standards under which the system was originally built will continue to govern its operation and maintenance. Removal of significant trees from an existing system should not be undertaken simply to accommodate evolving standards, but will require the same degree of consideration and local involvement as discussed under Design Considerations.